

v1.2



ROBOTIS CO.,LTD. www.robotis.com



contents

1 . Introduction 2

 1 - 1 . Functions 2

 1 - 2 . Composition 3

 1 - 3 . System Requirements 3

 1 - 4 . USB2Dynamixel Connection 4

 1 - 4 - 1 . USB2Dynamixel Structure 4

 1 - 4 - 2 . Connection of AX series Dynamixel 5

 1 - 4 - 3 . Connection with DX/RX series Dynamixel 6

 1 - 4 - 4 . Transformation of an USB port into a Serial port 7

 1 - 4 - 5 . Pin Figure 8

 1 - 4 - 6 . How to Supply Power 9

 1 - 5 . Installation 10

 1 - 5 - 1 . Installation of Driver 10

 1 - 5 - 2 . Installation and Implementation of the Dynamixel Manager 12

2 . Dynamixel Manager 15

 2 - 1 . Connection 15

 2 - 2 . List 16

 2 - 3 . Operation 17

 2 - 4 . Configure 20

 2 - 5 . Network 21

 2 - 6 . Information 22



1 . Introduction

1 - 1 . Functions



The USB2Dynamixel is a device used to directly drive the dynamixel on a PC. The USB2Dynamixel is used by connecting to a USB port of a PC, and is equipped with 3p and 4p connectors to be connected with a variety of dynamixels.

In addition, the USB2Dynamixel can be used to transform a USB port into a serial port for a PC without a serial port such as a lap-top computer. This function can be used effectively when dynamixel exclusive controllers such as the CM-2, CM-2+ and CM-5 are connected to an UBS port or when the ZIG2Serial is connected to an USB port to control a robot by radio.

Following pictures show how to use the USB2Dynamixel:

© Control of the USB2Dynamixel using a PC

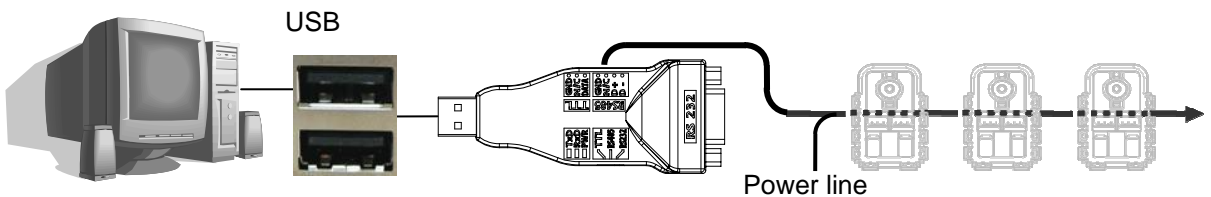

© Transformation of a Serial Port

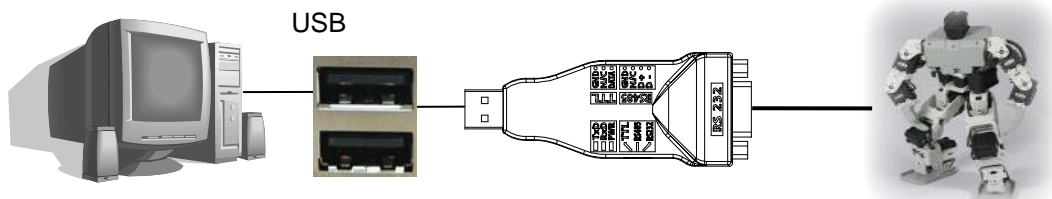

© Wireless Network

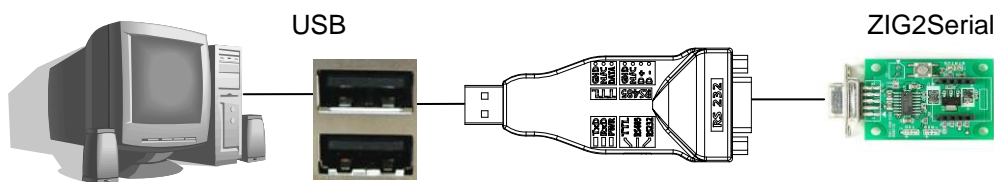

1 - 2. Composition

◎ USB2Dynamixel



The USB2Dynamixel is used when a dynamixel is directly driven on a PC without a dynamixel exclusive controller such as the CM-2, CM-2+ and CM-5. It is also used to transform an USB port to a serial port.

◎ Software



A software that can directly drive a dynamixel on a PC only with the USB2Dynamixel without a dynamixel exclusive controller such as CM-2, CM-2+ and CM-5 is provided. There are two types of software provided:

1. USB2Dynamixel driver
2. Dynamixel Manager

Downloadable from our website (www.robotis.com/usb2dynamixel)

◎ Manual



This manual describes how to install and use the USB2Dynamixel / Dynamixel Manager.

Downloadable from our website (www.robotis.com/usb2dynamixel)

1 - 3. System Requirements

- ◎ PC : PC compatible with IBM (required)
USB 1.1 or higher (required)
- ◎ OS : Windows 2000 or Windows XP (required)
- ◎ CPU : Intel Pentium III 1GHz , AMD Athlon XP 1GHz or higher (recommended)
- ◎ RAM : 256MB or higher (recommended)

1 - 4 . USB2Dynamixel Connection

1 - 4 - 1 . USB2Dynamixel Structure

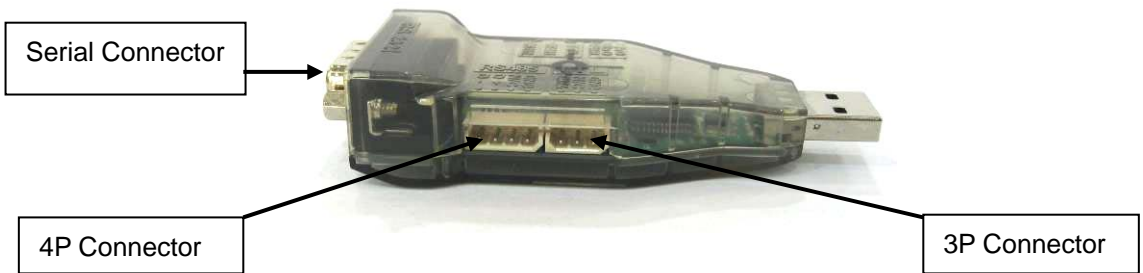
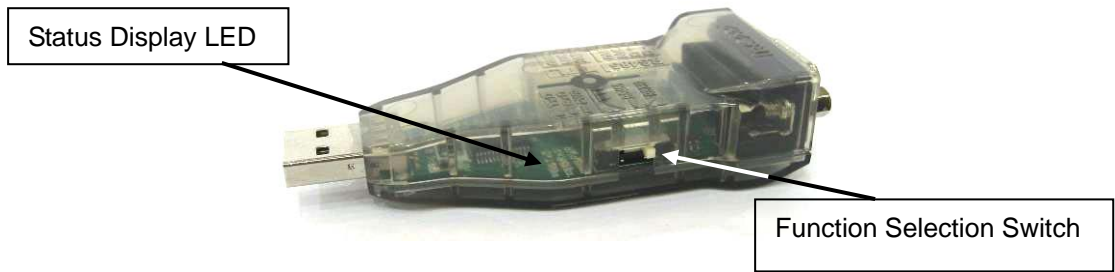

- Status Display LED : Displays the status of power supply, TxD (writing data), and RxD (reading data)
- Function Selection Switch : Selects how TTL, RS-485 and RS-232 communicates
- 3P Connector : Connects to AX series dynamixel using TTL network
- 4P Connector : Connects to DX or RX series dynamixel using RS-485 network
- Serial Connector : Transforms a USB port into a serial port using RS-232 network,

1-4-2. Connection of AX series Dynamixel

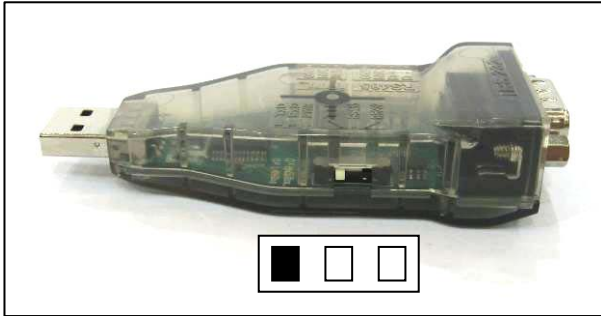

Set the function selection switch to TTL mode



Connect the 3P cable to the 3P connector of USB2Dynamixel and the connector of the dynamixel (There are two connectors on the dynamixel, any of which can be connected).



Dynamixels can be connected in series using a 3P cable.
Connect the power line to the last dynamixel.

POWER (DC 7 to 10V)



The USB2Dynamixel does not supply power to a dynamixel. For further information on how to supply power, please refer to 1-4-6 How to Supply Power.

1-4-3. Connection with DX/RX series Dynamixel

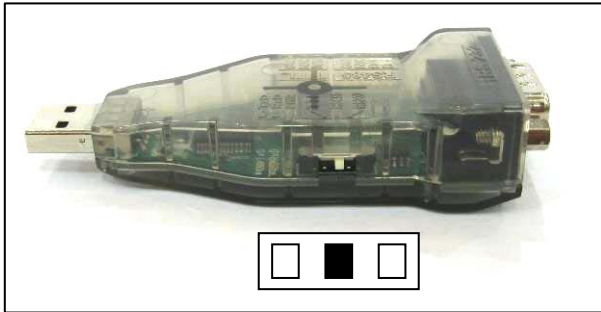

Set the selection function switch to RS 485 mode



Connect the 4P cable to the 4P connector of USB2Dynamixel and the connector of the dynamixel (There are two connectors on the dynamixel, any of which can be connected).



Dynamixels can be connected in series using a 4P cable.
Connect the power line to the last dynamixel.

POWER
 (RX-10: DC10 to 12V)
 (RX-28: DC12 to 16V)
 (RX-64: DC15 to 18V)
 (DX-117: DC12 to 16V)

1-4-4. Transformation of an USB port into a Serial port

The USB2Dynamixel can be used to transform an USB port into a serial port for a PC without a serial port such as a laptop computer.

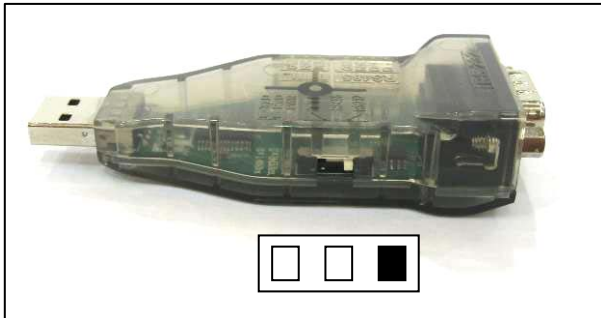

Set the function selection switch to RS 232 mode.

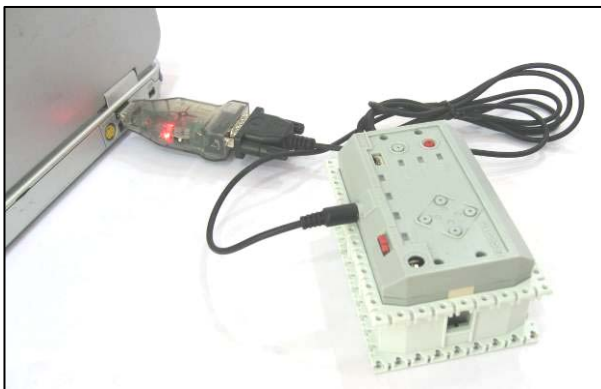

The CM-5 communicates using a serial port. When the USB2Dynamixel is used, the network with CM-5 can be made even using an USB port of a PC. For further information on this, please refer to the CM-5 manual

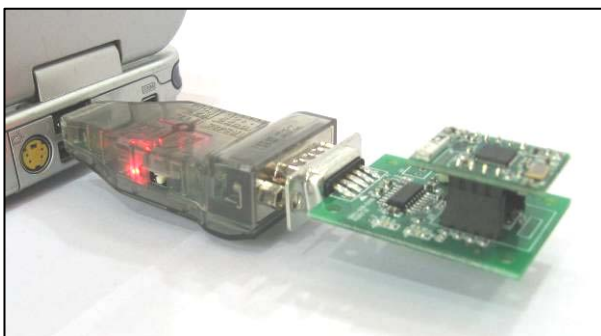

The ZIG2Serial can be used as an USB port using USB2Dynamixel. For this type of operation, the ZIG2Serial can be used without additional power supply. For further information on this, please refer to the ZIG2Serial manual.



Do not connect to an equipment that consumes more than 500mA, which may damage the USB board.

1 -4 -5. Pin Figure

The following pictures show the usage of the connector pins used in the USB2Dynamixel. To make them suitable for the intended purpose, the user should only use them after being familiarized with the usage of each pin.

Pin Figure of 4P/3P Cable Connector

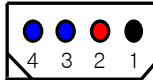
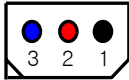
4 Pin Cable			3 Pin Cable		
Pin No.	Signal	Pin Figure	Pin No.	Signal	Pin Figure
1	GND		1	GND	
2	NOT Connected		2	NOT Connected	
3	DATA + (RS-485)		3	DATA (TTL)	
4	DATA - (RS-485)				

Pin Figure of Serial Connector

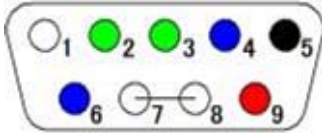
Pin No.	Signal	Pin Figure
1	Data (TTL)	
2	RXD (RS-232)	
3	TXD (RS-232)	
4	D+ (RS-485)	
5	GND	
6	D- (RS-485)	
7	Short with No. 8	
8	Short with No. 7	
9	USB power (5V)	

1-4-6. How to Supply Power

The USB2Dynamixel does not supply power to a dynamixel. Thus, additional power is needed to drive a dynamixel as shown below. For proper voltage to be provided to each dynamixel model, please refer to the dynamixel manual.

◎ Power Connection to the Dynamixel

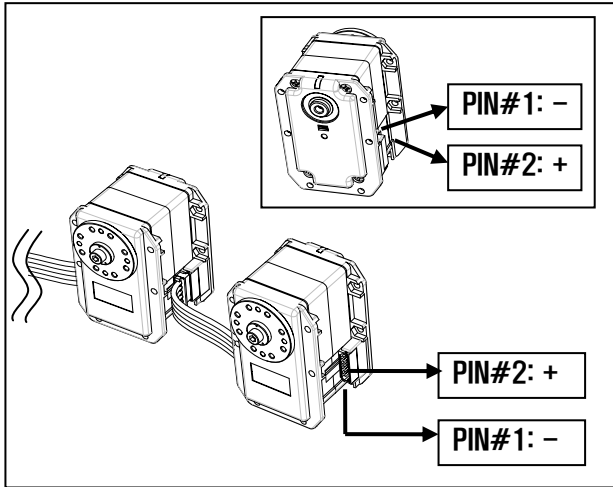

Based on the “1-4-5 Pin Figure”, connect the plus (+) power to the No. 2 pin of the connector, and the minus (-) power to the No. 1 pin (Since two connectors of the dynamixel are identical, the power can be connected to any one of them).

◎ Power Connection between the USB2Dyanmixel and Dynamixel

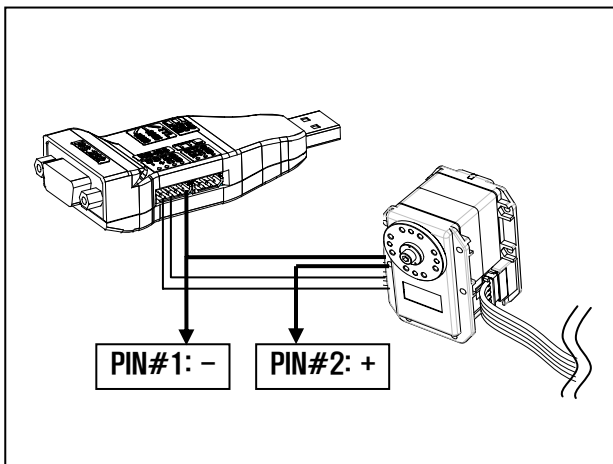

If the power cannot be connected to the dynamixel as above, connect the power between the USB2Dynamixel and the dynamixel as shown on the left.

Separate the wire connected to the No. 2 pin of the UBS2Dynamixel connector, and connect the plus (+) power to it. Connect additional wire via the Y winding to the wire connected to the No. 1 pin of the USB2Dynamixel connector, and connect the minus (-) power to it.

1 - 5. Installation

1 - 5 - 1. Installation of Driver

< Step 1 > Download the Dynamixel Driver file from our website and uncompress it.

(www.robotis.com/usb2dynamixel)

< Step 2 > Connect USB2Dynamixel to a PC, and the New Hardware Search window will appear on the PC. Click on [Install from the list or Specific Location].



< Step 3 > Move to where USB2Dynamixel driver folder which was uncompress from step 1.



< Step 4 > If the New Hardware Search window appears again, repeat the Step 2 to 3 one more time.



< Step 5 > Select Control Panel>> System>> Hardware>> Management Console.

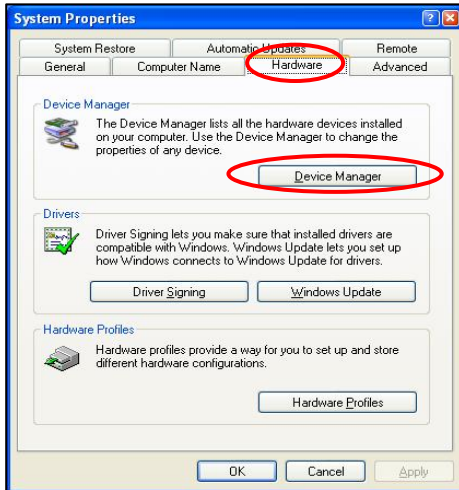

<Step 6 > Check whether “USB Serial Port” is installed at “Port (COM and LPT) of the Management Console. It would be convenient for the user to remember the number of port (COM #) for network connection.

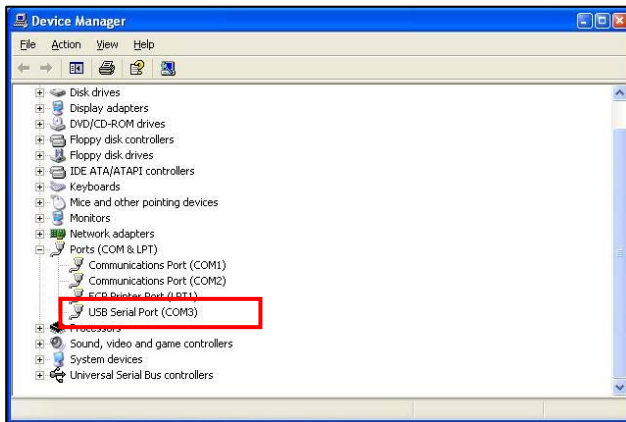

< Step 7 > Double-click on “USB Serial Port(COM#)”, and select “Port Setting >> Advanced” to modify the Latency time to 1ms. Doing such will increase the network speed.

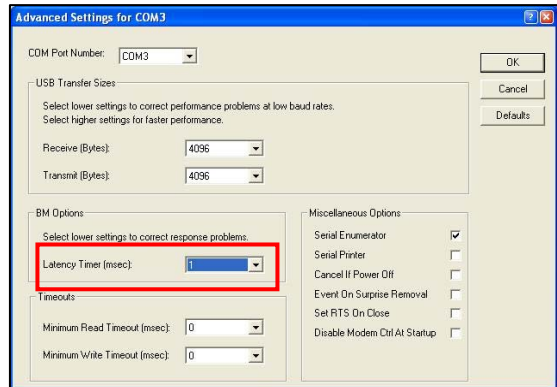
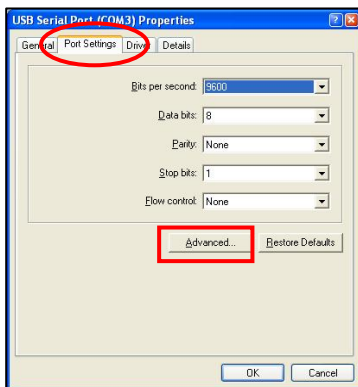

1 - 5 - 2 . Installation and Implementation of the Dynamixel Manager

< Step 1 > Make a connection of PC-USB2Dynamixel-Dynamixel as shown below, and supply power to the dynamixel unit(s). For further information on how to supply power, please refer to Section 1-4-6 How to Supply Power.

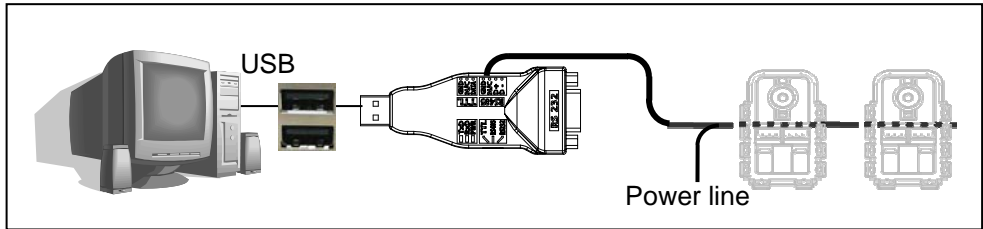

If the USB2Dynamixel driver is not yet installed on the PC and if the USB2Dynamixel is connected to the PC, the following window appears. In this case, install the driver by referring to Section 1-5-1 Installation of Driver.



< Step 2 > Download the Dynamixel Manager file, 'DynamixelManager.zip' from our website (www.robotis.com/usb2dynamixel)

< Step 3 > Decompress 'DynamixelManager.zip'. Execute the 'DynamixelManager.exe' file which was decompressed from the zip file.

< Step 4 > A window that sets the port of the PC appears. Select the communication port labeled 'USB Serial Port' which was added at the Management Console during the installation of the driver. The Dynamixel Manager displays all ports, including the USB2Dynamixel , that support USB2Serial. Thus, a port supporting the UBS2Dynamixel should be selected correctly. If the connection of the port is not correct, the dynamixel is searched when the 'Search' function in Step 5 is implemented.



< Step 5 > When the window searching the dynamixel appears, press the 'Search' button.

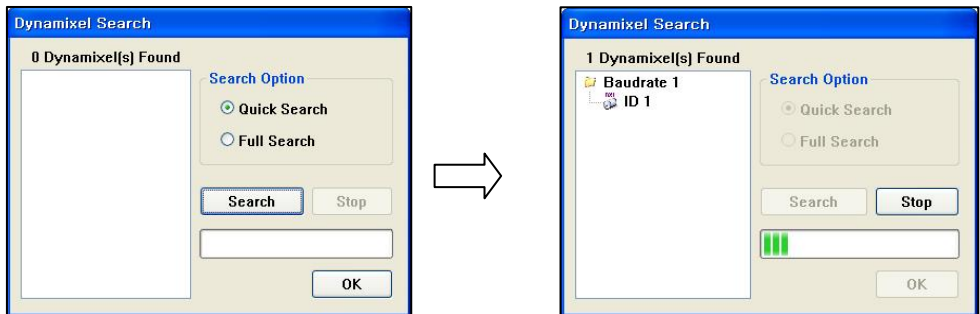

If the 'Search' cannot be implemented, redo 'Search' after checking the following:

1. Check whether the port is selected correctly.
2. Check whether the function selection switch of the USB2Dynamixel is located correctly.
3. Check the status of the connection between the USB2Dynamixel and the dynamixel and the status of power supply.
4. Quick Search is only possible when the Baud rate of the dynamixel is set to the main Baud rate. When the user has changed the Baud rate of the dynamixel arbitrarily, do not use the Full Search function.

< Step 6 > Dynamixel Manager will be implemented when the 'OK' button is pressed after the dynamixel is searched.

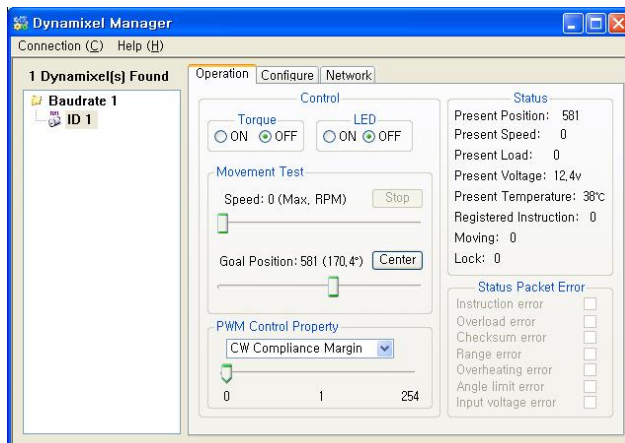

If there is a problem on the connection of the USB2Dynamixel, an error message appears as below. If the OK button is pressed, the Dynamixel Manager is implemented as below. In this case, restart from the Step 4 referring to the Connection menu of the Dynamixel Manager after checking the connection between the USB2Dynamixel and the PC.

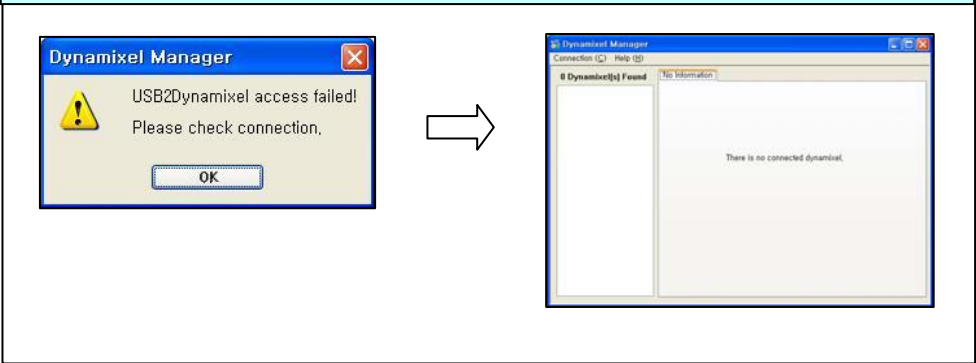

If there is a problem on the connection between the USB2Dynamixel and the dynamixel, an error message appears as below. In this case, restart from the Step 5 referring to the Connection menu of Dynamixel Manager after checking the status of the connection between the USB2Dynamixel and the dynamixel and the status of power supply.

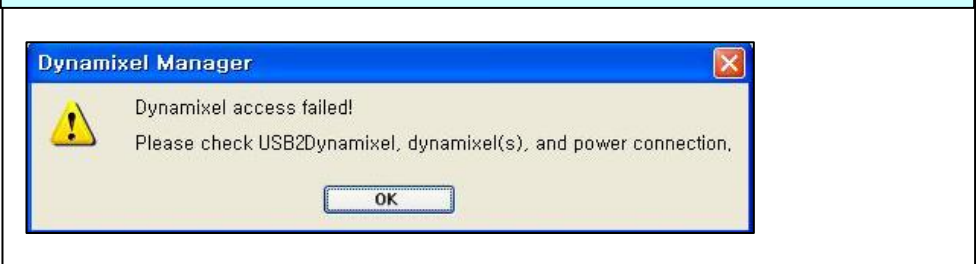

2. Dynamixel Manager

The Dynamixel Manager is a utility that helps manipulate a dynamixel from a PC easily. It can also change variables such as the ID or the Baud rate of the dynamixel.

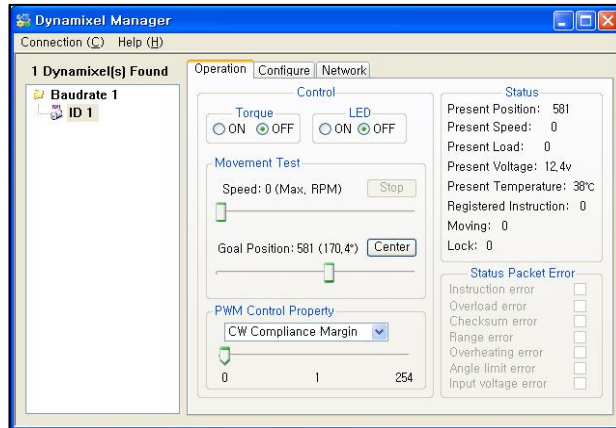

2-1. Connection

The Connection tab is used to set the connection status between the PC and dynamixel.



Open / Close

Opens or closes the network port of the USB2Dynamixel.

Search

Searches a dynamixel connected to the USB2Dynamixel.

Exit

Ends the Dynamixel Manager.

2-2. List

The List tab is used to show which dynamixel is connected to the USB2Dynamixel.

The following picture shows that there are a total of three dynamixels connected. Specifically, two dynamixels with the Baud rate 1 are connected, and their IDs are No. 1 and 4. A dynamixel with the Baud rate 34 is connected, and its ID is No. 2.

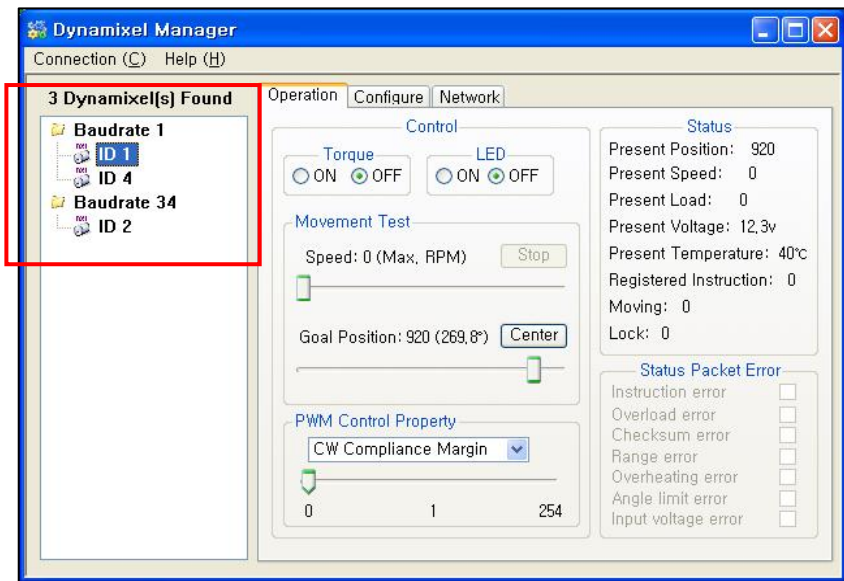

Only one dynamixel can be driven. To drive it, click on the corresponding ID.

When a communication error breaks out between the USB2Dynamixel and the dynamixel, click on the dynamixel in question, then the following error message appears. If the OK button is pressed, the dynamixel where the communication error broke out will disappear from the list.

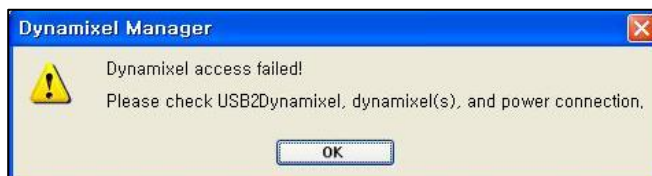

2-3. Operation

The Operation tab is used to drive the dynamixels.

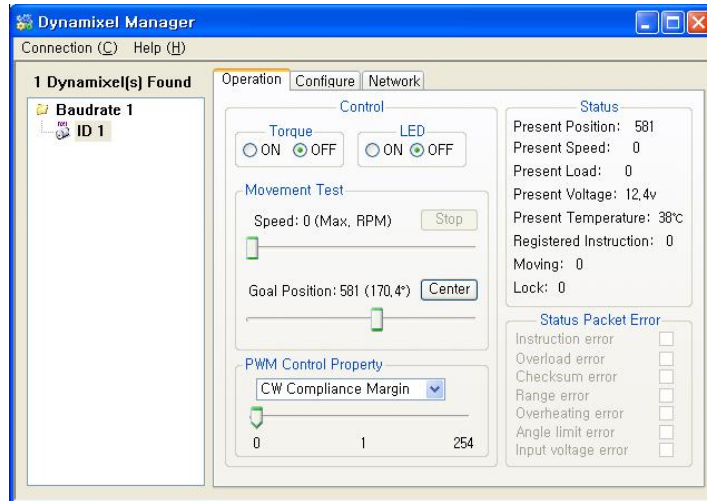

Torque

If 'On' is clicked, the output torque is applied to the dynamixel.



If 'Off' is clicked, the output torque of the dynamixel is removed.

LED

If 'On' is clicked, the LED of the dynamixel is turned on.

If 'Off' is clicked, the LED of the dynamixel is turned off.

Speed

Sets the driving rate of a dynamixel. Tune the rate by moving the scroll bar with the mouse. For the fine tuning, use the left and right direction keys [, ] on the keyboard. The value of Speed can be set 0 to 1023 as data value of rate. The value in the brackets is the value of RPM.

The **STOP** button is activated when Operation Mode is set to Wheel in Configure, and works as a function stopping the driving of Wheel.

The maximum driving rate of a dynamixel depends on the type of dynamixels and the level of connected voltage. Thus, in most cases, the maximum rate is achieved when the value of Speed is lower than 1023. The driving speed cannot be raised even if the value of Speed is set higher than the value of Speed at which the maximum driving speed reaches. For further information about this, please refer to

the manual of each dynamixel. The Speed value 1 is the lowest speed, and the Speed value 0 the highest.

Goal Position

Sets the driving angle of a dynamixel. Adjust it by moving the scroll bar with the mouse. For the fine tuning, use the left and right direction keys [←, →] on the keyboard. The value of Goal Position can be set 0 to 1023 as data value of position. The value in the brackets is the angle.

The **Center** button is to move the dynamixel to the center (Position Data: 512).

PWM Control Property A dynamixel can be smoothly driven by setting the value of PWM Control Property.

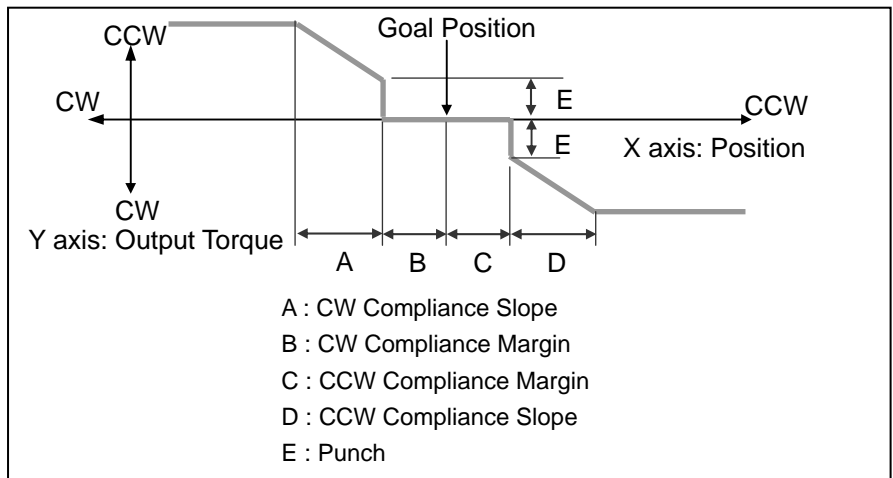

CW Compliance Margin

Sets a margin where torque is removed before arriving at Goal Position while moving it clockwise.

CCW Compliance Margin

Sets a margin where torque is removed before arriving at Goal Position while moving it counter-clockwise.

CW Compliance Slope

Sets a margin where torque is slowly removed before arriving at Goal Position while moving it clockwise.

CCW Compliance Slope

Sets a margin where torque is slowly removed before arriving at Goal Position while moving it counter-clockwise.

Punch	Sets the minimum value of output Torque.
Torque Limit	Sets the maximum value of output Torque.
Status	Displays the present status of a dynamixel.
Status Packet Error	Displays the nature of the error when an error occurs while a dynamixel is driving.

2-4. Configure

The Configure tab is used to set additional restrictive conditions necessary for driving a dynamixel. Save changed information by clicking on the Apply button after changing information.

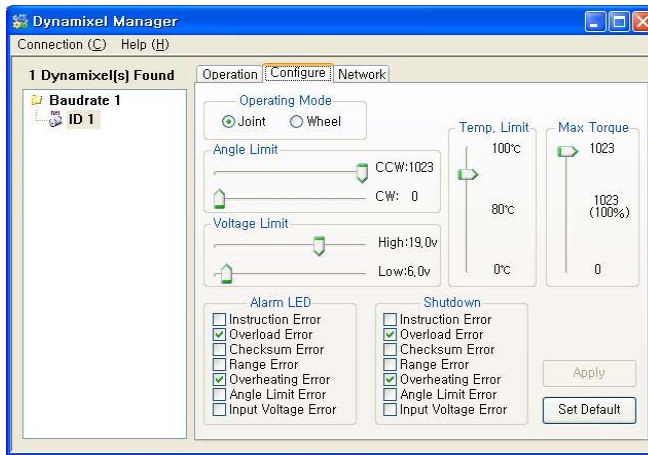

- Operation Mode** Selects a driving mode of a dynamixel.
 Joint: Used when the position/speed control is required like the joint of a robot.
 Wheel: Used when endless turn is required like a wheel.
- Angle Limit** Sets a driving angle. Angle Limit Error occurs when the system strays out of the set driving angle.
- Voltage Limit** Sets a level of connected voltage. Input voltage Error occurs when the connected voltage strays out of the set value.
- Temp. Limit** Sets the maximum value of operating temperature. Overheating Error occurs when the ambient temperature strays out of the operating temperature.
- Max Torque** Sets the maximum value of output torque.
- Alarm LED** When a selected error occurs, the LED is turned on
- Shutdown** When a selected error occurs, this removes output torque.
- Apply** Saves changed information by pressing the Apply button after changing information.
- Set Default** Restores the default values set in the factory from set information.
- Caution** If the maximum value of each function is set too low or if the minimum value is set too high, an errors may occur at a dynamixel.

2-5. Network

The Network tab is used to set the functions necessary for the network of the dynamixel and the PC. Save information by pressing the Apply button after changing information.

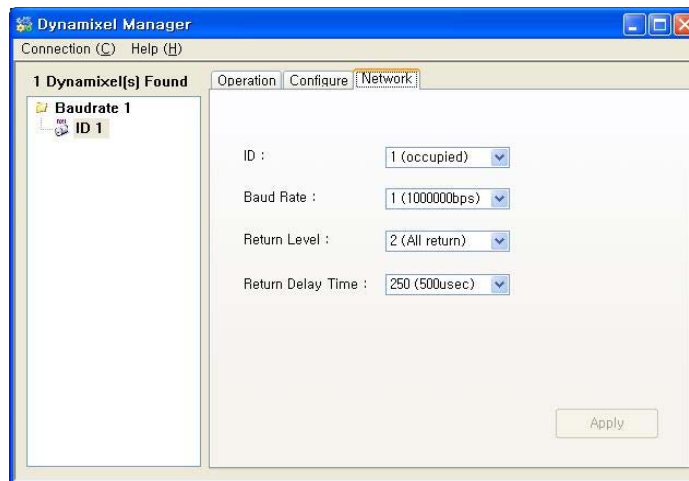

- ID** Sets the ID of a dynamixel. The ID connected to the USB2Dynamixel is marked as [Occupied]. The ID cannot be changed using an Occupied ID.
- Baud Rate** Sets the Baud rate between the dynamixel and the PC. It can only be changed to the main Baud rate.
- Return Level** Sets how a dynamixel returns the achieved output of an order to the PC. If the Return Level is set 0, the [Operation] and [Configure] functions cannot be used.
- Return Delay Time** There is a time delay between receiving the order of the dynamixel and returning the achieved output of the order to the PC. This menu sets the time delay occurring at this time.
- Apply** When the Apply button is pressed after information is changed, the changed information is saved.

2-6. Information

The Information tab displays information about the model and firmware version of the dynamixel connected at the moment.

