

dS378

User Manual Version 2.19

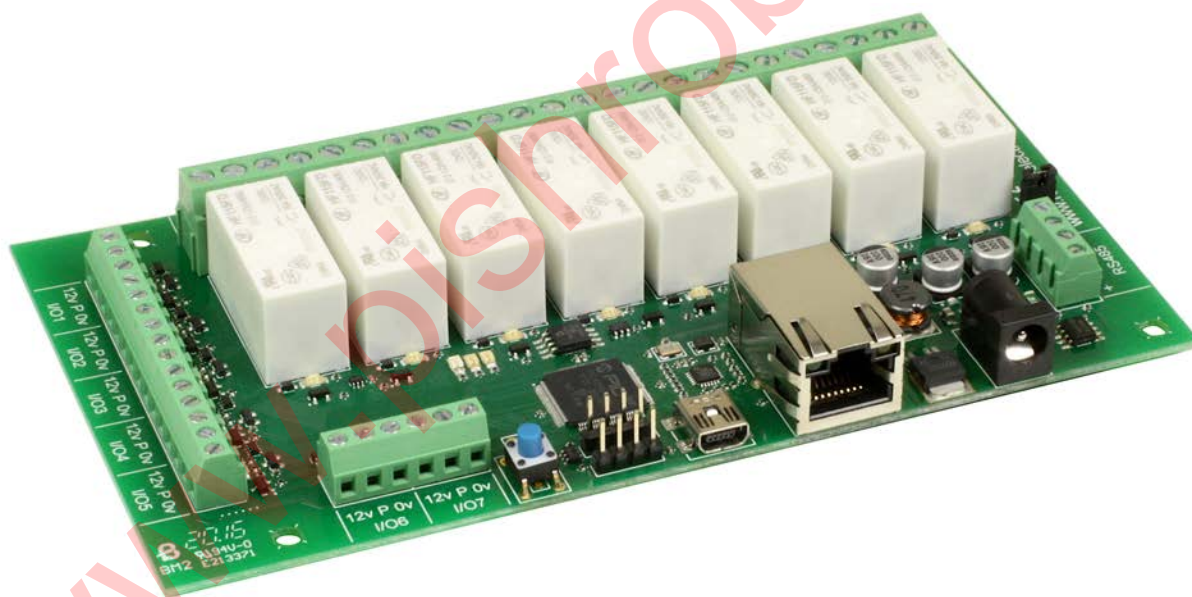

Table of Contents

Documentation history.....	3
A quick look.....	4
Introduction.....	5
Getting started.....	6
Configuring the dS378.....	8
Status page.....	9
Network page.....	10
TCP/IP page.....	11
Webpage security.....	12
Naming relays.....	14
Relay automation.....	15
Naming I/O's.....	16
Email notifications.....	17
Peer to Peer.....	18
Schedules.....	19
Counter/Timers.....	21
The application page.....	24
Application page security.....	25
Accessing your webpage from the internet.....	26
Boolean equations.....	27
TCP/IP command sets.....	29
ASCII command set.....	29
Binary command set.....	31
AES binary command set.....	33
Modbus commands.....	35
Function 01 (0x01) Read Coils.....	35
Function 04 (0x04) Read Input Registers.....	35
Function 05 (0x05) Write Single Coil.....	35
Error code 1.....	36
Error code 2.....	36
Error code 3.....	36
Loading the application firmware.....	37
dS378 hardware.....	39
LED indication.....	40
Power supply.....	40
Operating temperature.....	40
Power relays.....	41
Analogue/Digital flexible I/O's.....	42
Connection examples.....	42
Serial port connections.....	44
dS378 dimensions.....	45
Notes.....	46

Documentation history

V2.18	First release of separate dS378 manual
V2.19	Added new features:
	Peer to Peer Use events to control relays on another dSxxxx module.
	Schedules Create regular timed events
	Counters Count input transitions or seconds

www.pishrobot.com

A quick look

Ethernet connected module, 10/100Mb auto negotiated.

Relays – 8 x 16Amp 250Vac C/O.

I/O – 7 x flexible I/O's NPN output, Volt free input or 10-bit analogue input.

Power – 12VDC 1Amp supply required. 2.1mm center positive.

Connections – Screw Terminals for N/O N/C and Common contacts

PCB size – 156mm x 84mm

Controlled graphically by secure webpage or optionally one of ASCII, Binary or Modbus command sets over TCP/IP.

Email notifications – 8 selectable notifications, up to 100 emails/hour max.

Peer to Peer – Control relays on other modules.

Schedules – Able to schedule events based on time of day/week

Counter/Timers – Count or time events. 20 counts/second Max.

Also available when optionally programming in dScript are two TTL level serial ports and an RS485 serial port.

Introduction

The dS378 is an Ethernet connected relay module featuring 8 channels of 16Amp 250Vac relays. Each relay has both normally open (NO) and normally closed (NC) as well as the common available on three terminals.

In addition to the relays, the dS378 has 7 flexible I/O channels which may be individually configured to be:

1. NPN transistor output.
2. Active low input with pull-up (allows direct connection of volt free contacts).
3. Active low input without pull ups (easy to connect logic level inputs).
4. Analogue inputs (0v-3.3v input range).

The dS378 requires a 12v 1Amp power supply such as this one:

<http://www.robot-electronics.co.uk/universal-12vdc.html>

The dS378 has four built in control methods.

Primary control method is graphically by using its built in secure website.

Secondary control may be one of:

ASCII - type in commands via a program such as PuTTY.

Binary - Command set using binary codes

Modbus – Functions 1, 4 and 5 supported

And if you should wish to modify the supplied firmware – you can.

Behind the scenes there is dScript, a powerful multi-threaded operating system and programming language. The supplied firmware is written in dScript as well as HTML, CSS and Javascript on the webpages and the full source is in the separately down-loadable dScript package.

You do not need to use dScript at all, but its great to know its there - just in case you do.

Getting started

Start by plugging in the Ethernet cable to connect the module to your network, and the 12v jack plug from your adapter. Switch on and the first thing you will note is that the blue LED will flash 3 times. This indicates that the control firmware is loaded on the module. *(If the blue led does not flash you will need to load in the control firmware. Don't worry, this is very easy to do. Just go to the chapter on installing the firmware and follow the instructions there).*

If you are using a Win7/8/10 PC, open your browser and into the address bar (not the search bar) type:

http://dS378/index.htm

You should now see the application webpage and you can control relays and I/O's.

dScript



Ctrl1	<input type="text" value="469"/>	<input type="text" value="0"/>
Ctrl2	<input type="text" value="0"/>	<input type="text" value="0"/>
Ctrl3	<input type="text" value="0"/>	<input type="text" value="0"/>
Ctrl4	<input type="text" value="0"/>	<input type="text" value="0"/>

If you are not using a windows PC then you will need to find the IP address of the module. If you have a DHCP server on your network (your router is normally the DHCP server) then the dS378 will get its IP address from that. Log on to your router and navigate to the LAN client list.

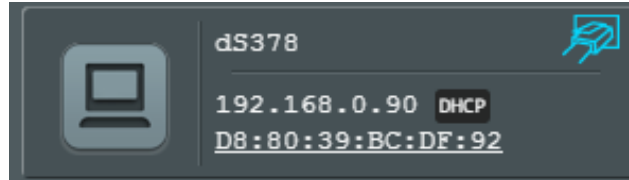

Above is the entry from our ASUS RT-N66U router. So now you type: 192.168.0.90/index.htm into your browser address bar and you should see the application webpage shown on the previous page.

If you prefer, you can download a java program that will run on Windows, MAC or Linux, and will list all of our modules that are connected to your LAN. DevantechModuleFinder.jar

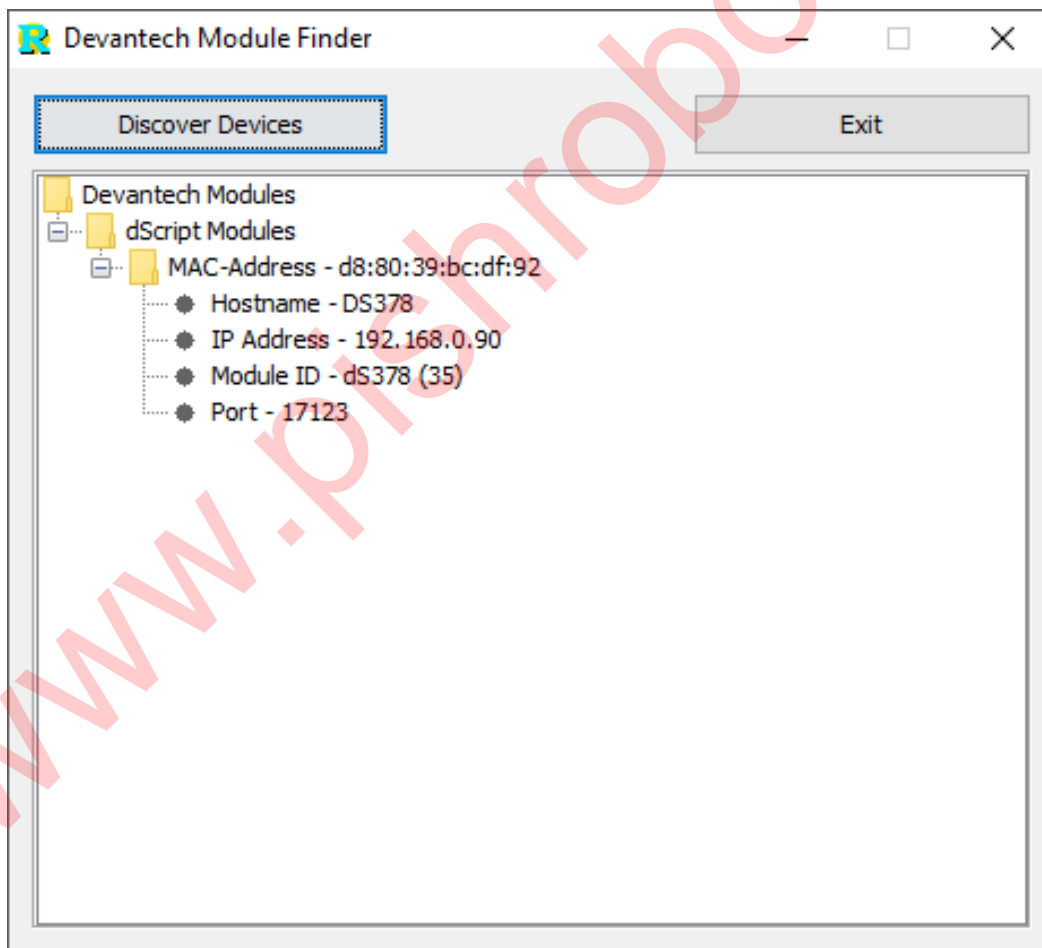

If you do not have a DHCP server the dS378 will use a default IP address of 192.168.0.123 so make sure your PC is on the same subnet of 255.255.255.0 and its IP address is 192.168.0.xxx

Configuring the dS378

There are a set of configuration pages to get the dS378 operating as you want it. These pages are all `_configx.htm`, (that's a leading underscore character).

ie.

`_config.htm`
`_config2.htm`

Anything that starts with `_config` is considered a special name for configuration pages and can only be seen if you have the the USB cable plugged in and connected to your PC.

Why only if the USB cable is plugged in?

Its an additional security measure. After you have configured and deployed the module, you really don't want these configuration pages available for others to change. So with the USB cable disconnected the `_config` pages are not available. If you try to access them you just get served a "not authorised" page instead.

So for now, you do want to look over the config pages. If you have a Win10, Linux or MAC PC, you can go right ahead and plug in the USB cable. These machines will install their own USB drivers. We won't be sending anything to the board, its just the presence of the USB connection that enables the config pages to be served. If you have a Win7 or Win8 PC you will need to install the drivers. (*go to the chapter on installing the firmware and follow the instructions there*).

With the USB cable connected, browse to:

192.168.0.90/`_config.htm`
(substituting your IP address)

Status page

You should now see the following page:

Module	dS378
System Firmware	2.19
Application Firmware	1.3
Supplied Voltage	12.1 Vdc
Internal Temperature	27.9 °C

This status page shows you the system and application firmware revisions as well as the supplied voltage to the board and its internal temperature.

If you hover your mouse cursor over the menu buttons on the left, the help panel will give you an overview of each one.

Network page

dS378 System Configuration Devantech Ltd

Host Name	dS378
IP Address	192.168.0.123
Subnet Mask	255.255.255.0
Gateway Address	192.168.0.1
Primary DNS	192.168.0.1
Secondary DNS	8.8.8.8
Enable DHCP	<input checked="" type="checkbox"/>

Network
Configure network IP address and associated parameters.

Update Pending

Notice that everything below the Host Name is greyed out and can't be changed. This is because the "Enable DHCP" box is checked and all the greyed out fields are supplied by the DHCP server. Although a quick way to get you connected, we really do not recommend this as the DHCP server can assign a different IP each time you power up. If you want to control this module from the internet while you are away from the premises then you will be setting up port forwarding on your router which requires a fixed IP address.

So lets do that first.

Uncheck the DHCP box and you can then set all the other fields. Notice that the Red "Update Pending" light comes on. It indicates there are changes which have not yet been written to the flash memory. It will go off again 5 seconds after you stop changing anything.

Choose an IP address for the module, something outside of the DHCP settings on your router so it will not assign anything to that address.

The subnet mask, Gateway and DNS can all be left as the defaults.

Network changes only take effect after the next re-boot, so wait until the "Update Pending" light goes out and give the reset button on the module a quick press. The Green Led will light and the Blue led will flash 3 times. You will now find the module at your new IP address. If the Red led comes on after you press the reset button, its because you pressed it for too long (and entered bootloader mode). Just have another go with the reset button for a bit less time.

Your browser won't know you have changed the IP address so it will still be showing the old, now dead page. Make sure you change to your new IP address and load the page again.

TCP/IP page

The TCP/IP tab allows you to select one of three command sets to control the module. These are independent of, and separate to the HTML webpage control.



Clicking on one of the four check boxes will select that command set. Only one command set may be selected. You can disable all TCP/IP command sets by clicking on an already selected box.

The ASCII command set is text based. You can use any program that can send text over TCP/IP. We use PuTTY in raw mode. The Binary command set operates in a similar way to our ETHxxx range of boards (but uses different commands), by sending binary commands to the module. AES Binary adds encryption. Note the AES key MUST be 32 bytes long. We have a test applications written in C# and Java to demonstrate AES encryption. The Modbus command set implements functions 1, 4 and 5.

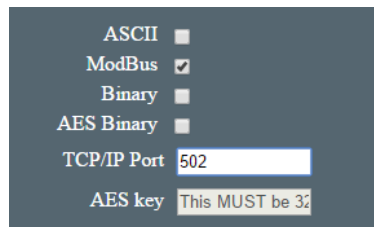

When selecting the Modbus command set, make sure you select port 502 which is the official port number for Modbus over TCP/IP.

A full description of the commands is in the "Command Sets" section later in this manual.

Webpage security

Allows you to prevent unauthorised personnel from accessing the application webpage or using it to control the module.

The screenshot shows the 'dS378 System Configuration' interface. On the left is a vertical menu with buttons for: Status, Network, TCP/IP, Webpage Security (highlighted), Relays, Input/Output, Email, Peer to Peer, Scheduler, Counter/Timer, and Application Page. The main area contains the following settings:

- Enable _pw.htm:
- Security Password:
- HTTP Port:

On the right, a 'Webpage Security' box contains the text: 'Configure the password for webpage security.' At the bottom right, there is a circular indicator labeled 'Update Pending'.

Leaving the Security Password blank will disable it and allow everyone to access the application page to control the module.

To enable password protection enter a password into the Password box. You can use any characters from the ASCII character set from 0x20 to 0x7E except " (0x22). It may be up to 200 characters long and you don't have to memorise it, so make it a long one with plenty of uppercase, lowercase, numbers and symbols.

Accessing a special webpage, _pw.htm, will install the password on your browser. To do this make sure the Enable _pw.htm box is checked.

This close-up shows the 'Enable _pw.htm' checkbox checked, the 'Security Password' field containing 'myNewPassword', and the 'HTTP Port' field containing '80'.

When the "Update Pending" light goes out, re-boot the module and go to yourIP/_pw.htm

You will see something like this:

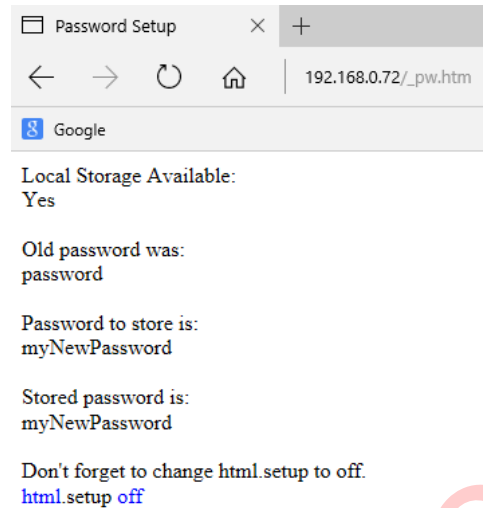

The password is now loaded on your browser. Do the same for any further browsers you want to enable. When you have done uncheck the "Enable _pw.htm" box to prevent anyone else from loading the password. When the "Update Pending" light goes out re-boot the module again.

The default port used by html webpages is 80. You can change this if required. If you do so then you will need to include the port number in the address. If you change the port to 2345 then the webpage will be at:
YourIP:2345/index.htm
For example:
192.168.0.123:2345/index.htm

Naming relays

The next tab allows you to set the names of the 8 relays that will be displayed on the application page.



Names may be up to 20 characters long, but keep them shorter if you want to use a phone as the controller. Here we have renamed relay 4 as "YardLights" and those 10 characters are about the limit on a vertical Galaxy S6 screen.

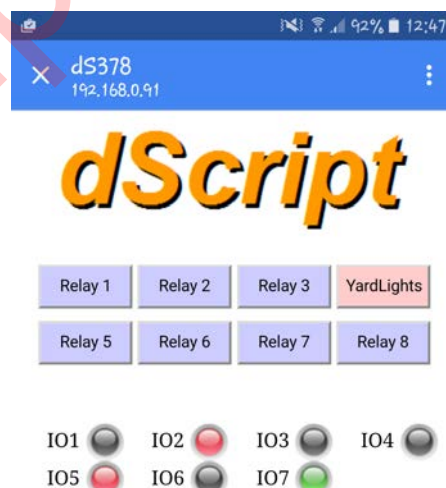

Relay automation

The box to the right of the relay name box is used to give a little automation to the relay. Leave this blank (or zero) for normal operation, that is just toggling the relay on/off from the button on the application page.

If you place a number in this box then that is the pulse time for the relay in mS (1000mS = 1 second). The minimum value is 100mS. The maximum is 2147483647 (more than 24 days). When the relay is toggled on timing begins and at the end of the time period the relay goes off again. If the button is pressed again during timing then the timing is restarted.

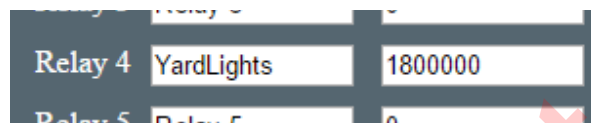

The above example will turn off the yard lights after 30 minutes. 1800000 mS is 1800 seconds. 1800 seconds is 30 minutes.

It also possible to insert a boolean equation into the automation box. Boolean equations are just simple equations that evaluate to a 0 or 1.

For example Relay 1 is referred to as R1. I/O1 is referred to as D1 (Digital 1). Analogue input 1 is referred to as A1.

Here's a very simple example:



Enter R1 into the Relay 2 automation box. This will make relay 2 copy whatever you do to Relay 1. Try it!

Now change it to !R1.



The exclamation mark is read as "Not R1". Now relay 2 will always be the opposite of relay 1. Try it.

Boolean equations are used for controlling relays and also to trigger email notifications.

See the "Boolean equation" section later in this manual for full documentation.

Naming I/O's

The I/O Names tab is used to assign meaningful names to the I/O terminals.

dS378 System Configuration Devantech Ltd

I/O 1	I01	Digital No-Pullup
I/O 2	I02	Digital No-Pullup
I/O 3	I03	Digital With Pullup
I/O 4	I04	Digital With Pullup
I/O 5	I05	Digital With Pullup
I/O 6	I06	Analog
I/O 7	I07	Analog

I/O Configuration

Names.
These are the I/O labels on the application page to give each I/O a unique and descriptive name. Maximum 20 characters.

Types.
Configure Digital I/O with or without pull-up resistors, or analogue inputs with 4.096v or 5v reference.

Update Pending

As with relay names these may be up to 20 characters long, but do check it looks ok on a mobile device or whatever you are using to control the module.

The I/O types box allows you to select the type of I/O you want.

The two digital modes are the same except for "Digital No-Pullup" the passive pullup resistor is turned off and for "Digital With Pullup" it is turned on. The no-pullup option is useful for connecting to digital circuits (3.3v or 5v) that supply the input voltage. The with pullup option turns on a weak pull up to 12v (actually nearer 7-8v because of the input design). This is useful for directly connecting volt free contacts such as relay contacts or switches. They are connected between the pin (P) and ground (0v).

To use as inputs, make sure the output drive is off or the NPN transistor will drive the output low. The NPN transistor can sink about 100mA.

The analogue mode converts the input voltage to a digital number in the range 0-1023 (10-bit conversion). The input voltage range is 0-3.3v.

When you have changed I/O types wait for the "Update Pending" light to go out and press the reset button, as new I/O modes are set on power-up.

Email notifications

The final configuration tab is the Email tab for sending secure, AES encrypted email notifications from the module.

The screenshot shows the 'dS378 System Configuration' web interface. On the left is a sidebar with navigation buttons: Status, Network, TCP/IP, Webpage Security, Relays, Input/Output, Email (selected), Peer to Peer, Scheduler, Counter/Timer, and Application Page. The main area contains configuration fields for an email notification: 'Email No.' with a dropdown set to '1', 'Email Address' with the text 'youname@example.com', 'Subject' with 'Event message goes here', and 'Trigger' with 'D1'. Below these fields are eight radio buttons, with the first one selected. To the right is a box titled 'Easy Mail' containing the text 'Send secure emails in response to selected events.' At the bottom right of the main area is a radio button labeled 'Update Pending'.

Up to eight (8) email notifications may be set up, selected by the eight radio buttons.

Setting up emails is quick and easy. You just need the recipients email address, a notification message which will be the email subject line and the trigger event.

The trigger event uses the same boolean equation solver as the relay automation. So if you want to trigger an email when digital input 1 (I/O1) becomes active, just enter D1.

The email message is automatically filled in with useful information on the state of the relays, I/O's etc.

Boolean equations are used for controlling relays as well as triggering email notifications.

See the "Boolean equation" section later in this manual for full documentation.

Note - Email notifications are limited to 100/hour.

Peer to Peer

This tab allows you to configure events on this module to control relays on another.

Up to eight (8) Peer to Peer events may be set up, selected by the eight radio buttons.

Control of the target relay is by using the binary command set only. This can optionally use AES encryption. The Target module must be set to either Binary or AES Binary mode on its TCP/IP tab, and this "Use AES" checkbox set to match.

The input box selects the event that will be used to control the target relay. This can be as simple as an input, or a complex Boolean equation. See the "Boolean equation" section later in this manual for full documentation.

Target IP, Port & Relay No should be set to locate the target relay.

Target action determines how the relay will be controlled.

0 - No action, this Peer to Peer event is disabled.

1 - Follow Me, the relay will follow the input, (or the Boolean result of any equation here).

2 - Set Relay, the relay will be set by this event. You will need another P2P event to reset it.

3 - Reset Relay, the relay will be reset by this event. You will need another P2P event to set it.

4 - Toggle Relay, this will toggle the relay each time the event is triggered.

100+ - Pulse relay, Pulse times are in mS. (1000mS=1Second).

5-99 will have no action.

Schedules

The scheduler can schedule regular events. These can be once or twice daily with the two start and stop times and can happen on any selected weekdays.

The screenshot shows the 'Scheduler' configuration page in the dS378 System Configuration interface. On the left is a sidebar with menu items: Status, Network, TCP/IP, Webpage Security, Relays, Input/Output, Email, Peer to Peer, Scheduler (highlighted), Counter/Timer, and Application Page. The main configuration area includes:
- Schedule No.: 1
- Target Relay: 3
- W/Days: S, M, T, W, T, F, S (all days are highlighted in red)
- Start 1: 6:30:00
- Stop 1: 7:45:00
- Start 2: 4:30:00
- Stop 2: 22:15:00
- Current Time: 14:38:37
- Time Zone: 0
- Daylight Saving:
- Update Pending button
- A 'Scheduler' box on the right contains the text: 'Schedule daily events with 8 schedules, 2 events per schedule and a week day mask.'

The Schedule No. is one of eight schedules that can be set up. These are selected with the eight radio buttons at the bottom of the screen.

The target relay is the local relay that you want this schedule to control.

W/Days selects the days of the week you want this schedule to control the relay. When highlighted in red, the weekday is active.

There are two sets of Start and Stop times for each of the eight schedules. The relay is set when the start time transitions from inactive to active, ie. at the start time, and reset when the stop time is reached. It is not held on or off. It can be changed by other events including the webpage buttons.

The current time originates from an internet time server. It is read only and cannot be changed. Therefore you must have an internet connection for the scheduler to operate correctly.

The timezone allows you to set the time for your location.

For example;
GMT leave this at 0.
CET set this to 1.
PST set this to -8
IST set this to 5:30

Daylight saving time may be checked if required. It advances the time by 1 hour between the last Sunday in March and the last Sunday in October.

As well as controlling a relay directly, schedules may also be used in the boolean equation fields of other controls. A relay could be controlled by placing S1 (for schedule 1) in its automation field.

www.pishrobot.com

Counter/Timers

Count input pulses or time events.



There are a total of eight counter/timers available, selected with the 8 radio buttons. Each counter can count at a maximum speed of 20Hz (20 counts per second).

Counter Name

Each counter/timer may be named and this name appears on the application page and email notifications.

Count Input

Each counter/timer is capable of being a timer by entering T1 into its count input box. T1 is an internal 1Hz timer that will advance the count once per second. If an input is specified then any pulses on that input will be counted. D4 will count pulses on input 4.

Capture Input

This is the event that will cause the current counter value to be stored in the capture register. The capture register is displayed on the application page, and may also be read using the TCP/IP commands.

Reset Input

This input will reset the counter value to zero. If the capture input has been left blank then it will store the current counter value in the capture register before resetting it to zero. You may use an input such as D3 or you can use the counter value itself. Entering C1>9 for the counter1 Reset Input will reset the counter when it reaches 10. This will create a repeating 10 step timer (0-9).

Counters, Timers and Schedules can be combined. As an example lets assume we want to count the pulses on input 2. We need to know the number of pules per hour coming in. First we need a 1 hour time base, we'll use counter/timer 1 for this.

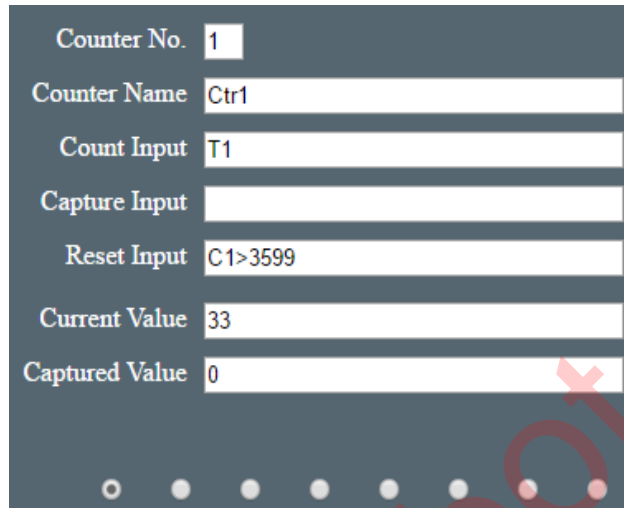

A screenshot of a configuration interface for Counter 1. The interface has a dark blue background with white text and input fields. The fields are: Counter No. (1), Counter Name (Ctr1), Count Input (T1), Capture Input (blank), Reset Input (C1>3599), Current Value (33), and Captured Value (0). At the bottom, there are seven small white circles, with the second one from the left being highlighted.

Using T1 for the count input will make the counter increment once per second. There are 3600 seconds in 1 hour so we reset the counter when its greater than 3599 with C1>3599. The counter will count from 0-3599.

Next we will use counter 2 to do the counting of input 2 pulses.

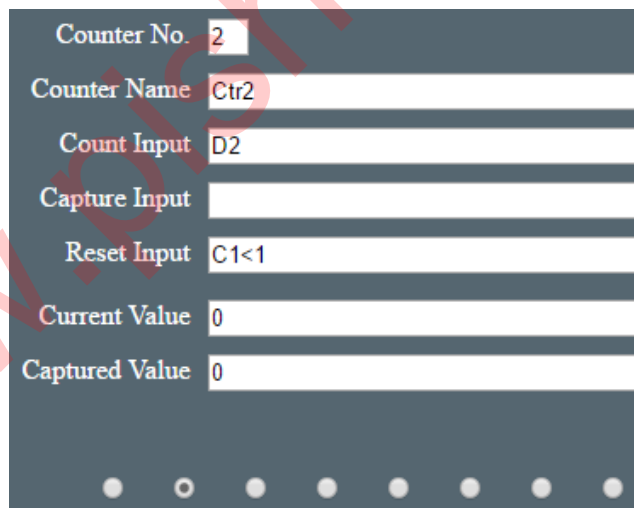

A screenshot of a configuration interface for Counter 2. The interface has a dark blue background with white text and input fields. The fields are: Counter No. (2), Counter Name (Ctr2), Count Input (D2), Capture Input (blank), Reset Input (C1<1), Current Value (0), and Captured Value (0). At the bottom, there are seven small white circles, with the second one from the left being highlighted.

The count input is set to D2 to count the pulses. The reset input is controlled be counter 1. When it gets reset to zero each hour, so does counter 2. As the capture input is blank the reset event also captures the count value. This may be read any time in the next hour.

The internal time base, T1 is derived from the crystal on the module. It's accurate but will drift

over time so that the capture event may not happen "on the hour". Even if you started it on the hour it will drift out by a few seconds a day. So as a final refinement we will synchronize our time base with the real time derived from a schedule.

Schedule No.	1		
Target Relay	0		
W/Days	S M T W T F S		
	Hours	Minutes	Seconds
Start 1	0	0	0
Stop 1	0	0	2
Start 2	0	0	0
Stop 2	0	0	0
Current Time	15	29	9
Time Zone	0		
Daylight Saving	<input checked="" type="checkbox"/>		

The target relay is set to zero as we don't need to use any relays for this. All week days are set so we perform the synchronization every day. Start/stop time 1 is used to activate the schedule at 1 second past midnight each day. The second start/stop time is disabled as both times are identical.

Now go back to counter1 and add "|S1" to the reset input. Now our time base timer will reset every hour or when schedule1 triggers it.

Counter No.	1
Counter Name	Ctr1
Count Input	T1
Capture Input	
Reset Input	C1>3599 S1
Current Value	2497
Captured Value	0

The application page

The last tab in the configuration pages takes you directly to the application page so you can quickly see the results of your configuration changes.

dScript

The screenshot displays the dScript application interface. At the top, there is a grid of eight relay status buttons labeled Relay 1 through Relay 8. Relay 2 and Relay 4 are highlighted in red, indicating they are active, while the others are blue. Below the relays, there are seven I/O indicators labeled IO1 through IO7, each with a circular status light. IO1 is red, IO3 is green, and IO7 is red. IO2, IO4, IO5, and IO6 are grey. To the right of the I/O indicators, there are four control input fields labeled Ctr1 through Ctr4, each with a numerical value and a reset button. Ctr1 has the value 469, while Ctr2, Ctr3, and Ctr4 have the value 0.

Relay 1	Relay 2	Relay 3	Relay 4
Relay 5	Relay 6	Relay 7	Relay 8

IO1 IO2 IO3 IO4
IO5 IO6 IO7

Ctr1	469	0
Ctr2	0	0
Ctr3	0	0
Ctr4	0	0

The I/O indicators show grey when the I/O is inactive. When an active input is applied they show green. Red indicates an active output from the module.

The I/O's are clickable just like the relay buttons to turn them on and off.

Application page security

The configuration pages (any page name starting with `_config`) are only served when the USB port is connected. If the USB port is unplugged then no configuration pages are served. Instead, you will be served a page saying "You do not have permission to view this page."

The `_pw.htm` page (which contains the javascript that loads the password into your browser) will only be served when the enable `_pw.htm` checkbox is checked on the Webpage Security tab.

If the password field is left blank, the application page will always be served – to anyone! Entering a password means the application page will only be served to a browser that has the matching password set. Everyone else will just be served a simple webpage saying "You do not have permission to view this page."

To summarize, set a password, load it onto your browser, disable `_pw.htm` and un-plug the USB cable. Now you, and only you, can access and control your module.

Accessing your webpage from the internet

Now you have your webpage up and running on your local network, for example 192.168.0.150, and you can access the webpage and control the module. You just go to 192.168.0.150/index.htm, and the page is there.

However you can't get directly at that page from your phone when you are away from home. You can't access it on 192.168.0.150 because your network is not publicly accessible, its a private network address. You will have another IP address. This is the one your ISP gave you for your internet connection, and is the public IP address of your router on the internet. If you don't know what it is you can type "my ip" into Google's search bar and it will tell you. This is the IP address you will use to access the modules webpage.

Everything on the internet uses an IP address and a port number. When you access a webpage in your browser all you enter is the IP address (or more likely a domain name, but its ultimately translated to an IP address). You don't normally have to enter a port number but its still required. Your browser simply uses the default port number, which is 80 for the web, unless otherwise specified our modules also use port 80 for the webpage. However its a good idea to use a different port number for our boards as this will avoid conflict with any web server you may have on your network. Pick a number, I'll choose 19321 as our port number. Just make sure its different from any TCP/IP port number you are using. The HTML port is set on the Webpage Security tab.

After you have re-loaded the program you can access the webpage with:
192.168.0.150:19321/index.htm

Note that as we have changed the modules html port we need to tell the browser how to find the page with the new port number. Do that by inserting a ':' character and the port number between the IP address and the page name as shown above.

Assuming your routers internet IP address is 86.87.88.89 (I made that up – replace with your actual IP address) you will access the page from anywhere with address:
86.87.88.89:19321/index.htm

However first you have to set up your router to do that. It's called "port forwarding" or "virtual server", but whatever your router calls it, you need to set it up so that all incoming connections on port 19321 are forwarded to port 19321 on local IP address 192.168.0.150.

Unfortunately there are so many routers out there we cannot give details on all of them. You should consult your routers manual or search Google for details on your specific router.

Boolean equations

Both relay automation and email triggering use the boolean equation solver.

The three types that can be used in boolean equations are:

1. Relays, R1 – R8
2. Digital I/O's, D1 – D7
3. Analog inputs, A1 – A7
4. Schedules, S1 – S8
5. Counters, C1 – C8
6. 1Hz Time base, T1

The simplest equation is R1. This is true when R1 is active and not true when R1 is in-active. If you enter R1 in the relay 2 automation box it will simply follow whatever R1 does.

The exclamation mark ! is used as a "not". So !R1 is true when relay 1 is in-active. Enter !R1 in the relay 2 automation box it will follow the opposite of R1. Relay 2 will be active when relay 1 is inactive.

The same applies to the digital I/O's. Enter D2 in the relay 2 automation box and the relay will follow the input.

Analog inputs are compared with a value to obtain a true/false boolean result. In this example we have set I/O8 to be an analogue input with a 5v reference. Then we can enter $A1 < 1000$ in the relay2 automation box. This will turn on relay 2 when the input A1 falls below 1000. If A1 is connected to a temperature sensor and R2 controls a heater – well, you get the idea. Analog comparisons use the "less than" < and "greater than" > symbols only. There is no equal or not equal. Checking for equality on a potentially jittery analogue input is not really useful.

As well as "not" !, you can use "and" & and "or" | in your equations. Enter $D2 \& D3$ and the result is true only when both D2 and D3 are active. Enter $D2 | D3$ and the result is true when either D2 or D3 is active.

What happens here:

$D2 | D3 \& D4$

The answer is that boolean expressions are evaluated left to right. So D2 is Ored with D3 and the result ANDed with D4. You can change the order of precedence by using parenthesis ().

$D2 | (D3 \& D4)$

will now AND D3 with D4 and the result is Ored with D2.

To demonstrate a real world example, take the analog example above where we compared A1 with 1000 to operate R2. Whilst this would work its a not a good solution as the relay would jitter badly when A1 was hovering between 999 and 1000. What we need is some hysteresis. To do that we will use R2 in its own equation.

$(A1 < 1000 \& !R2) | (A1 < 1234 \& R2)$

Assume R2 is inactive (off). The 2nd half of the equation $(A1 < 1234 \& R2)$ will have no effect.

So when A1 falls below 1000 the relay comes on. Now the 2nd half of the equation is true, and will stay true until A1 climbs above 1234.

So the relay becomes active when A1 is below 1000 and inactive above 1234.

We have hysteresis!

www.pishrobot.com

TCP/IP command sets

There are four TCP/IP command sets on four selectable check boxes, of which one or none may be selected on the TCP/IP config tab. These are ASCII, Modbus, Binary and Binary with AES256 encryption.

ASCII command set

The ASCII command set allows you to type commands using a TCP/IP terminal program such as PuTTY. Use PuTTY in raw mode.

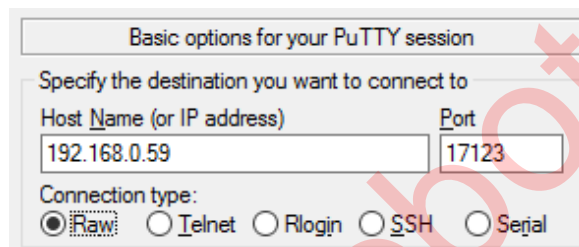

Make sure you have you module set to ASCII mode and, after the "update Pending" indicator has gone out, re-booted the module so the changes take effect.

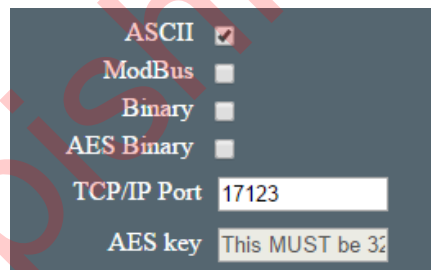

ASCII commands are all two character commands and are not case sensitive. Type ST followed by the return key. This is the SStatus command. You will see:

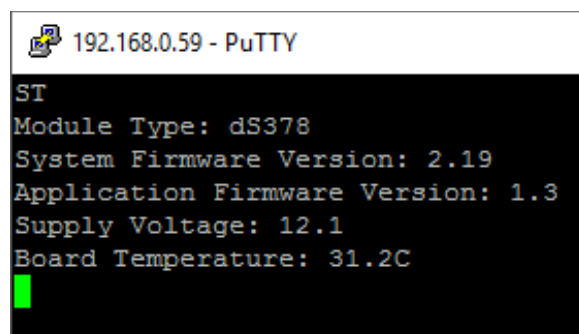

Valid commands are:

ST SStatus request

SR [Relay number] [on/off] {Pulse time in mS}

SR 1 on Set Relay 1 on

SR 1 off Set Relay 1 off

SR 1 on 1000 Set Relay 1 on for 1 second

SO [Output number] [on/off]

SO 1 on Set Output 1 on

SO 1 off Set Output 1 off

GR [Relay number]

GR 1 Get relay 1 status – responds with Active or Inactive

GI [Input number]

GI 1 Get Input 1 status – responds with Active or Inactive

GA [Analog Input number]

GA 1 Get Analog input 1 – responds with the 10-bit analog value

GC [Counter number]

GC 1 Get Counter1 – responds with count, capture values.

Note – on the dS378, GI and GA are identical, getting the digital state or analogue value depending on the port configuration in the I/O Types tab.

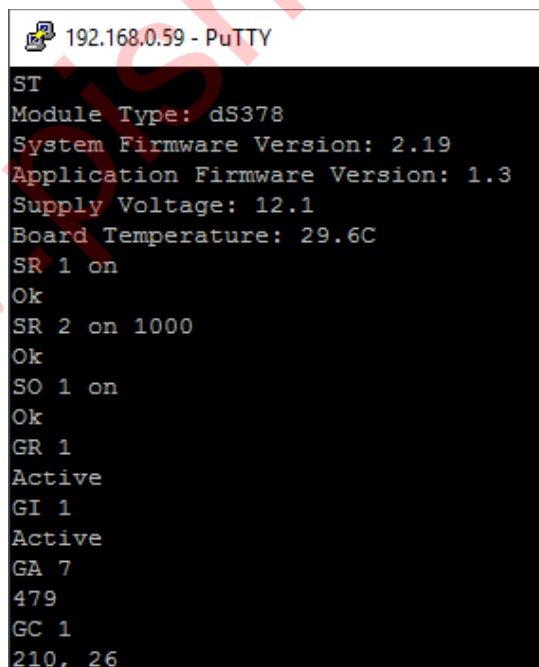

```
192.168.0.59 - PuTTY
ST
Module Type: dS378
System Firmware Version: 2.19
Application Firmware Version: 1.3
Supply Voltage: 12.1
Board Temperature: 29.6C
SR 1 on
Ok
SR 2 on 1000
Ok
SO 1 on
Ok
GR 1
Active
GI 1
Active
GA 7
479
GC 1
210, 26
```

Typical PuTTY session.

Binary command set

Summary.

0x30 Get Status
0x31 Set relay
0x32 Set output
0x33 Get Relays
0x34 Get Inputs
0x35 Get Analogue
0x36 Get Counters

0x30 (decimal 48) Get Status (1 byte command, returning 8 bytes)

This command returns 8 bytes of status data

Module ID	This will be 35 (0x23) for the dS378
System Firmware Major	2 for example
System Firmware Minor	18 for example
Application Firmware Major	1 for example
Application Firmware Minor	2 for example
Volts	Power supply volts x 10. Example 125 is 12.5v
Internal Temperature (high byte)	x 10
Internal Temperature (low byte)	combined to 16 bits, 267 = 26.7 degrees C

In the above example the returned bytes would be:

0x22 0x02 0x12 0x01 0x02 0x7D 0x01 0x0B

The last two bytes combined are 0x10B which is 267 decimal.

0x31 0x02 0x01 0x00 0x00 0x00 0x00 Set Relay (7 byte command, returning 1 byte)

This command turns a relay on or off or pulses it for a time period and returns an ACK/NACK byte. ACK=0, NACK=non-zero (actually the unknown relay number).

0x31 The actual command, the rest are parameters.

0x02 Relay number. Valid numbers are 1-8 (0x01-0x08)

0x01 Turn relay on (0x00 for off). This is ignored when following pulse time is >100.

0x00 } high byte Pulse time

0x00 } mid high These 4 bytes combined are a 32-bit pulse time for the relay

0x00 } mid low when less than 100 (as it is here 0x00000000) its ignored

0x00 } low byte When >100 this pulses relay on for that number of mS

To pulse relay 5 on for one second the command is:

0x31 0x05 0x00 0x00 0x00 0x03 0xE8

0x000003E8 (or just 0x3E8) is 1000 decimal, which is 1000mS or 1 second.

The relay will turn on and then go off 1 second later.

When sending a relay pulse time, the relay on/off byte is ignored. The relay is always on for the duration of the pulse.

Binary Command Set – continued.

0x32 0x04 0x01 Set Output (3 byte command, returning 1 byte)

This command turns an output on or off and returns an ACK/NACK byte. ACK=0, NACK=non-zero (actually the unknown I/O port number).

All I/O's which need to be inputs should have the output turned off. When turned on the NPN transistor can sink up to 100mA.

0x32 The command, the rest are parameters

0x04 the I/O number, 4 in this case.

0x01 on (0x01) or off (0x00)

0x33 0x01 Get Relay (2 byte command – returning 2 bytes)

This command is used to get the states of the relays. The second byte is the relay number, relay 1 in this case.

The first returned byte is the state of the requested relay, 0x00 (off) or 0x01 (on) the 2nd byte packs the states of all 8 relays. Bit 7 is relay 8 through to bit 0 which is relay 1.

	Byte 2							
Bit No.	7	6	5	4	3	2	1	0
Relay	8	7	6	5	4	3	2	1

If the bit is set the relay is on, zero otherwise.

0x34 0x01 Get Input (2 byte command – returning 2 bytes)

This command is used to get the states of the inputs. The second byte is the input number, input 1 in this case.

The first returned byte is the state of the requested input, 0x00 (inactive) or 0x01 (active) the second byte packs the states of all 7 inputs. Bit 7 is unused. Bit 6 is input 7 through to bit 0 which is input 1. If the bit is high the input is active.

	Byte 2							
Bit No.	7	6	5	4	3	2	1	0
Input	x	7	6	5	4	3	2	1

Binary Command Set – continued.

0x35 Get Analogue inputs (1 byte command returning 14 bytes)

This returns all 7 possible analogue inputs. 14 bytes are returned, 2 for each analogue input.

Byte 1 byte 2 for example:
0x02 0x3E combined to 0x023E, or 574 decimal for input 1.

Byte 3 byte 4 combined to 0x01FB, or 507 decimal for input 2.
0x01 0xFB

Bytes 5 – 12 follow in a similar way.

Byte 13 byte 14 combined to 0x032C, or 812 decimal for input 7.
0x03 0x2C

If the input is configured as a digital port then the input will be 0 or 1.

0x36 0x01 Get Counters (2 byte command – returning 8 bytes)

This command is used to get the counters. The second byte is the counter number, counter 1 in this case.

The first 4 bytes returned is the current counter value. This 32-bit (4 bytes) value is returned high byte first. The second group of 4 bytes returned is the capture register for this counter, also a 32-bit (4 byte) value returned high byte first.

AES binary command set

The AES Binary commands are the same as the Binary commands described above. The only difference is that they are AES encrypted and always 16 bytes in length. The first bytes are the same as described in the Binary command set. The last 4 bytes is the Nonce (a random number) and the bytes in the middle are undefined. The module will decrypt the command, generate the response and encrypt it before returning it to you.

Your program that controls the module will need to encrypt the commands and then decrypt the response.

We use AES256 CBC encryption, hence the requirement for a 256 bit (or 32 byte) key. To complete the security we use a random IV generated by a cryptographically secure random number generator (ISAAC).

To control the module you will need to send the commands with AES encryption. To help you with this we have examples in C#, Java and Python. The C# and Java applications are complete and may be used or modified as you wish.

To prevent re-play (or Playback) attacks the command packet includes a Nonce. This takes the form of a 32-bit (4 byte) random number in positions 12, 13, 14 & 15 of the 16 byte data packet. For example when you send a Get Status command (0x30) you will get a 16 byte block returned. The first 8 bytes (0-7) will be as defined for the binary commands. Bytes 8-11 are unused. Bytes 12-15 contain the Nonce.

Commands with generate and send you a Nonce are:

- 0x30 – Get Status
- 0x31 – Set Relay
- 0x32 – Set Output

Commands which require a Nonce to be sent by you are:

- 0x31 – Set Relay
- 0x32 – Set Output

A Nonce is only ever used once, you must always use the most recently issued Nonce.

The following example shows how the Nonce provided by the module is used in the next Set Relay or Set Output command.

	0	1	2	3	4	5	6	7	8	9	10	11	12	13	14	15
Get Status	0x30	xx	xx	xx	xx	xx	xx	xx	xx	xx	xx	xx	xx	xx	xx	xx
Response	0x23	0x02	0x12	0x01	0x02	0x7D	0x01	0x0B	xx	xx	xx	xx	0x89	0xAB	0xCD	0xEF
Set Relay	0x31	0x02	0x01	0x00	0x00	0x00	0x00	xx	xx	xx	xx	xx	0x89	0xAB	0xCD	0xEF
Response	0x00	xx	xx	xx	xx	xx	xx	xx	xx	xx	xx	xx	0x1A	0x2B	0x3C	0x4D
Set Relay	0x31	0x03	0x01	0x00	0x00	0x00	0x00	xx	xx	xx	xx	xx	0x1A	0x2B	0x3C	0x4D
Response	0x00	xx	xx	xx	xx	xx	xx	xx	xx	xx	xx	xx	0xF1	0xE2	0xD3	0xC4
Set Output	0x32	0x04	0x01	xx	xx	xx	xx	xx	xx	xx	xx	xx	0xF1	0xE2	0xD3	0xC4
Response	0x00	xx	xx	xx	xx	xx	xx	xx	xx	xx	xx	xx	0x5C	0x47	0x9B	0xED

If the Nonce you send with the command does not match the last one sent to you, then the Relay (or Output) will not be changed.

No other commands either require or provide a Nonce.

Modbus commands

The modbus command set accepts a subset of the standard Modbus-TCP frames as defined in [Modbus protocol Specification](#) and [MODBUS Messaging on TCP/IP Implementation Guide V1.0b](#)

Functions 1, 4, & 5 are supported along with error codes 1, 2 & 3 should they occur.

Function 01 (0x01) Read Coils

This function reads back the 8 relays as coils 1-8 and also the 7 inputs as coils 9-15.

Function 04 (0x04) Read Input Registers

This function reads back the 7 analogue inputs as registers 1-7

Register 8 is always zero

Registers 9-24 are 16 registers representing 8 counter values. As modbus registers are 16-bits wide and the counters are 32-bit, a counter is stored in 2 16-bit registers, high word first. In the same way, the 16 registers 25-40 hold the 8 capture values.

Register 9	Counter1 high word	Register 25	Capture1 high word
Register 10	Counter1 low word	Register 26	Capture1 low word
Register 11	Counter2 high word	Register 27	Capture2 high word
Register 12	Counter2 low word	Register 28	Capture2 low word
Register 13	Counter3 high word	Register 29	Capture3 high word
Register 14	Counter3 low word	Register 30	Capture3 low word
Register 15	Counter4 high word	Register 31	Capture4 high word
Register 16	Counter4 low word	Register 32	Capture4 low word
Register 17	Counter5 high word	Register 33	Capture5 high word
Register 18	Counter5 low word	Register 34	Capture5 low word
Register 19	Counter6 high word	Register 35	Capture6 high word
Register 20	Counter6 low word	Register 36	Capture6 low word
Register 21	Counter7 high word	Register 37	Capture7 high word
Register 22	Counter7 low word	Register 38	Capture7 low word
Register 23	Counter8 high word	Register 38	Capture8 high word
Register 24	Counter8 low word	Register 40	Capture8 low word

Function 05 (0x05) Write Single Coil

This function is used to write to a single coil (relay or I/O). Coils 1-8 are the relays 1-8. Coils 9-15 are the I/O's 1-7 remapped to coils 9-15.

Error code 1

This error is returned if an unknown or unimplemented function is received. Only functions 1, 4 & 5 are implemented.

Error code 2

This error is returned if an illegal address is requested. Addresses greater than 15 for functions 1 & 5 or greater than 7 for function 4 will generate this error.

Error code 3

This error is returned if an illegal data value is received. Number of points = zero will generate this as will an illegal data value for function 5.

www.pishrobot.com

Loading the application firmware

If your module does not flash the blue LED three times on power-up, you will need to update the system firmware and load the application program. These instructions should also be followed if you want to update your firmware to the latest version or even revert to an earlier version.

You need to download the dScript programming environment from here:
<http://www.robot-electronics.co.uk/files/dScriptPublish.php>

PC requirements

Windows 7 or later

USB port to program the module.

The dScript IDE is supplied as a zip file that can be download and unzipped into a temporary folder, inside the temporary folder will be four folders:

Installation

USBdriver

Examples

Documentation

Go to the Installation directory and click "setup" to install the dScript IDE, if you have already installed a previous version you will need to uninstall it before installing the new one.

The USBdriver folder contains the USB com port driver for the modules.

Copy the Examples directory to a convenient location on your computer, it contains both dScript source code examples and associated web pages, one of which is the application firmware you will need.

In this order:

1. Start from this position:
 - a. dScript Editor closed down.
 - b. dS378 not connected or powered.
2. Power-up the dS378.
3. Connect the USB lead to the PC. If windows wants a driver, point it to the USB driver folder and install the driver from there.
4. Hold down the reset button for a couple of seconds until the red LED comes on. This indicates the module is in boot-loader mode.

5. Run the dScript editor. Look in Help→About and check you have the latest version of dScript. In this case 2.19

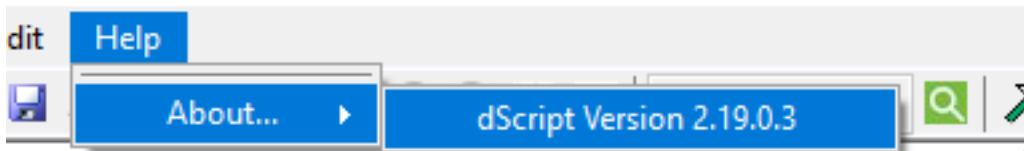

If you have an earlier version you should uninstall it and install the new version from the installation folder, then start these instructions from the beginning. Older versions will not work with the new application.

6. Now look in the Module panel, you should see:



v1.01 indicates it's the boot-loader that is running.

7. Click the file open button (or File→Open) and load:
\\dScriptPublish\Examples\dS378-v.13\dS378-v1.3.dsj

8. Make sure the webpage folder is correctly set.

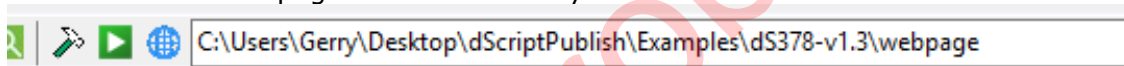

Substitute the path for where you placed the dScriptPublish folder.
Click the blue world button if you need to search for the folder.

9. Click the build button (white triangle on green button). This will update the system firmware and load the application.

10. When done, the new version will be displayed:

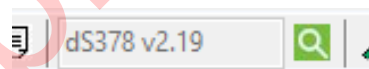

dS378 hardware

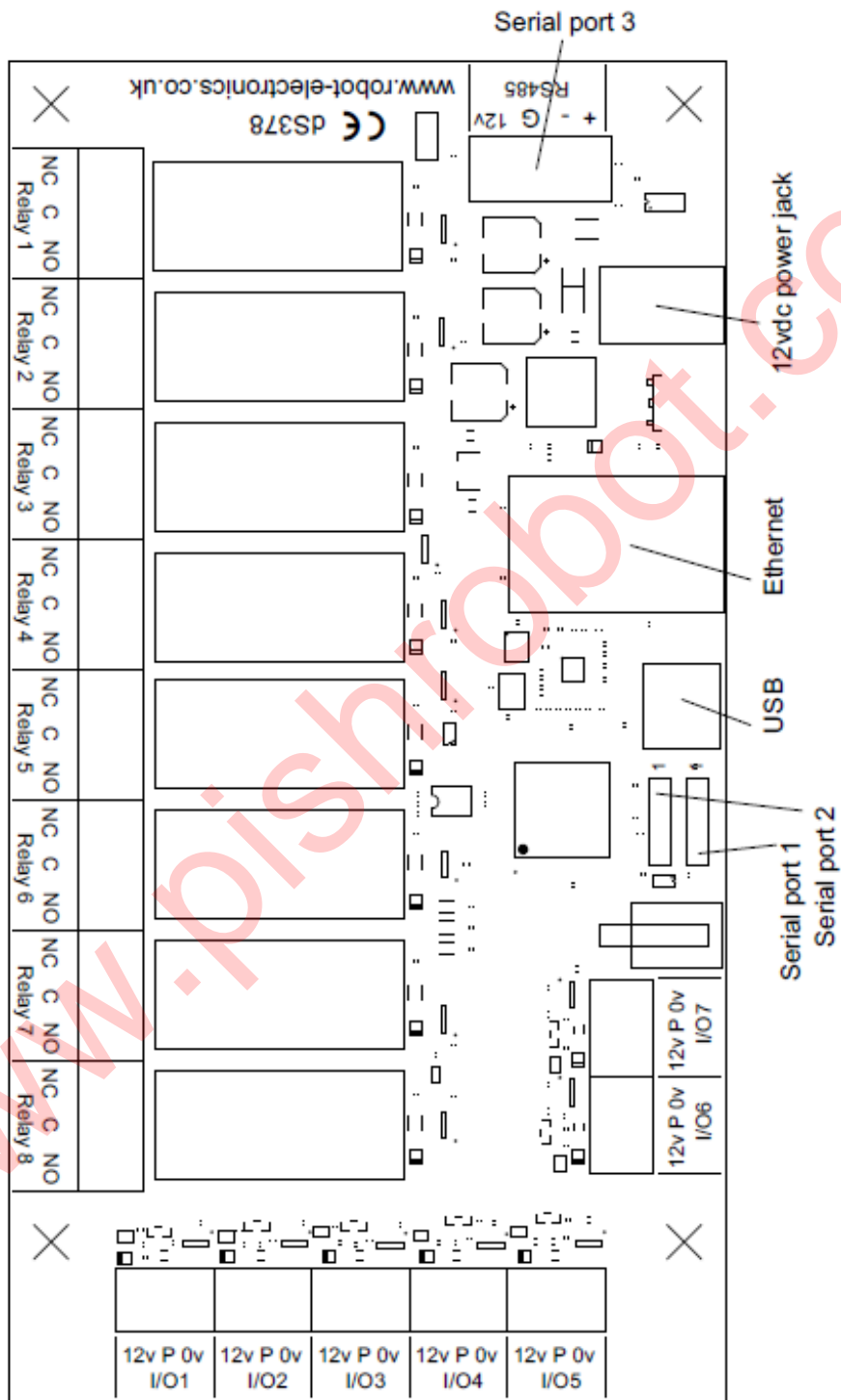

The dS378 provides eight (8) volt free contact relay outputs with a current rating of up to 16Amp each, 7 flexible I/O's which can be analogue or digital, 2 serial ports (3.3v level) and an RS485 serial port. The module is powered from a 12vdc supply which can be regulated or unregulated. The relays are SPCO (Single Pole Change Over) types. The normally open, normally closed and common pins are all available on the screw terminals.

LED indication

The dS378 provides a red LED mounted immediately next to each relay to indicate whether it is in a powered state (LED on), there are also two LED's mounted in the Ethernet connector which will flash with Ethernet traffic. A row of three LEDs, Blue, Green and Red, are available for status indication. The Red LED lights when the module is in bootloader mode – this is when the IDE is uploading system firmware to the module. The Green LED lights the board begins running user programs. All three LEDs are available and can be controlled as digitalports 32-34.

<code>digitalport</code>	LedBlue	32
<code>digitalport</code>	LedGreen	33
<code>digitalport</code>	LedRed	34

The "FlashingLeds" example provides a colourful display showing how to use them.

There are also LEDs on the I/O lines. These indicate the I/O status in digital output and VFC input modes only.

Power supply

The dS378 requires a 12v DC supply capable of supplying a minimum of 1A. This is most easily provided by a low cost mains adapter. A suitable universal adapter is available on our website and may be ordered along with the modules. Connection is via the 2.1mm DC jack socket. Positive on the center pin.

Operating temperature

-40C to +70C

Power relays

Eight 16A volt free contact relays are provided for switching a common input between a normally closed output and a normally open output. The relay coil is powered by the 12vdc incoming supply on user command.

Relay in passive state

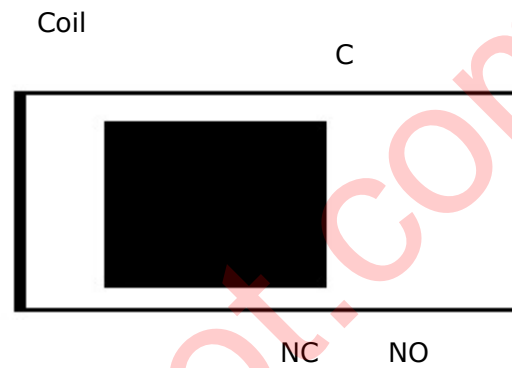

Relay in powered state

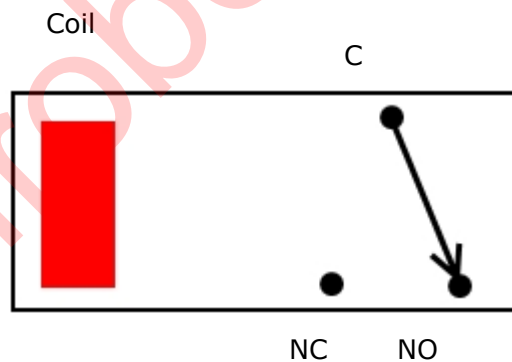

A full datasheet for the relays used on the dS378 is here: [HF115FD datasheet](#)

Analogue/Digital flexible I/O's

The dS378 has seven flexible I/O ports, numbered 1-7, which can be your selection of:

1. Digital open collector output.
2. Digital open collector output with passive pullup to 12v
3. Digital input (0-12v, 2.5v threshold).
4. VFC (Volt Free Contact) input.
5. 10bit Analogue input, range 0-3.3v (internal supply voltage)

Connection examples

Example input - connecting a switch

Connecting a simple switch could not be easier, just wire the switch between a pin (P) and ground (0v). When the switch closes the input will become active.

Make sure you use the 1 option in the digitalport declaration to enable the ports passive pull-up

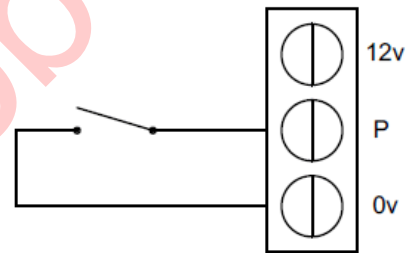

Example output - connect a relay

You can connect your own 12V relays (200mA max), the first coil pin of the relay is wired to the 12V supply terminals on the board, the other is wired to the output pin (P). When the output pin becomes active it is driven down to 0V ground, the relay will have 12V across the terminals and switch, so COM is connected to NO (Normally Open).

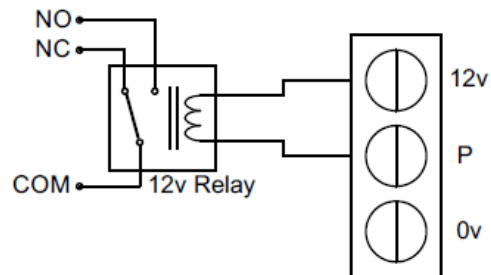

Representative flexible I/O schematic

P1 controls the passive pull-up. It is automatically disabled in analogue modes and set by the option in the digitalport declaration in digital modes.

Q1 controls the open collector NPN output. It is set by writing to the port.

D1 is the ports input. It supplies the 10bit ADC in analogue modes and is read as 0 or 1 in digital modes.

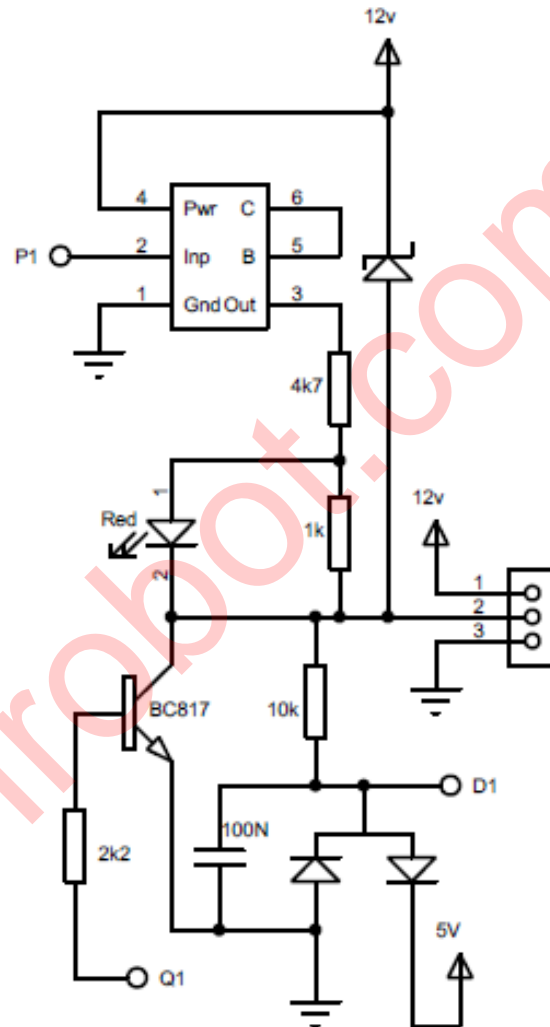

Serial port connections

TTL serial port.

The dS378 has two serial port headers, 1 and 2 in dScript.

Pin 1 is marked on the PCB.

Tx and Rx operates at 3.3v levels, however the Rx input is 5v tolerant. Most 5v TTL level serial ports will accept a full 3.3v input ensuring the port is compatible with most 5v devices such as the LCD05 display modules. That is the reason 5v (rather than 3.3v) is available on pin1 to power external modules.

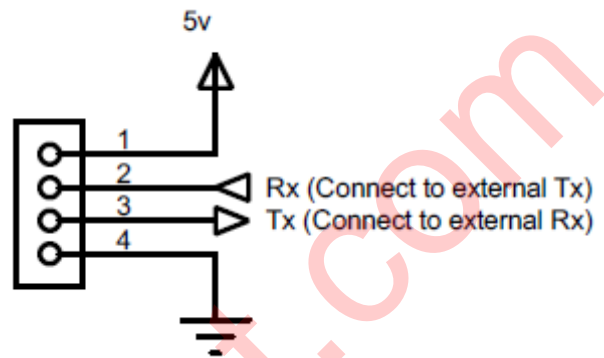

RS485 serial port.

Referred to as serial port 3 in dScript.

The 12v power is not part of the RS485 specification, it is there to provide convenient power for any 12v sensors you may wish to connect such as our SRF485 ultrasonic rangars.

Connections for the RS485 port are also clearly labeled on the PCB.

The two pin link near to the RS485 terminal block should be shorted to use the on-board 120 ohm terminating resistor.

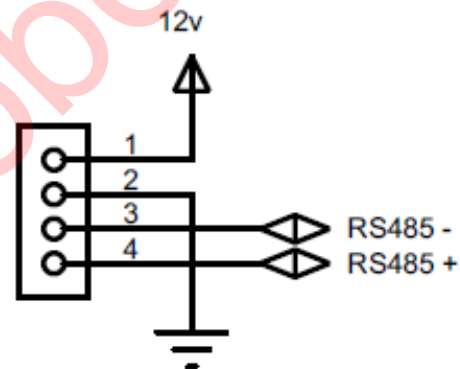

Notes.

1. Serial ports are available when programming in dScript

dS378 dimensions

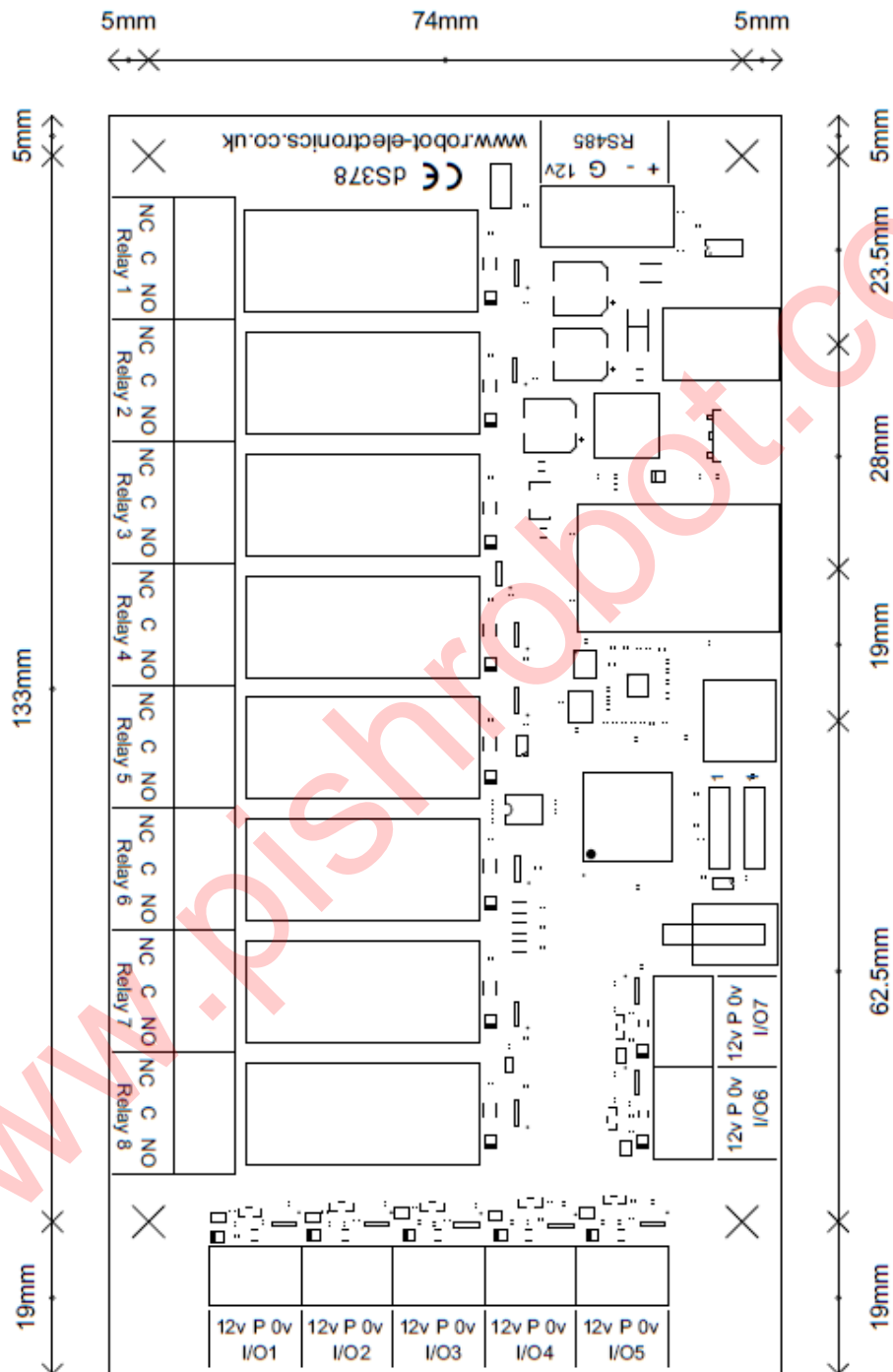

Notes

www.pishrobot.com